

# Corning® Matribot® Bioprinter

## Instruction Manual

Catalog Number: 6150

CORNING



## Table of Contents

<b>1. Safety Information</b> .....	<b>1</b>	4.4 Biodispensing droplets .....	21
1.1 General safety information .....	1	4.4.1 Start a Droplet project.....	21
1.2 Unpacking, lifting, and carrying.....	1	4.4.2 Print surface .....	22
1.3 Electrical information .....	2	4.4.3 Printer settings .....	23
1.4 Protective equipment .....	2	4.4.4 Printhead settings .....	24
1.5 Hazardous materials .....	2	4.4.5 Calibration and Automatic bed-leveling (ABL) .....	25
1.6 Electrostatic discharge (ESD) protection.....	2	4.4.6 Print model.....	27
1.6.1 Procedures .....	2	4.5 Utilities.....	28
1.6.2 Discharging yourself .....	2	4.5.1 Extrusion tab.....	28
<b>2. Specifications</b> .....	<b>3</b>	4.5.2 Temperature tab.....	28
2.1 Product map .....	3	4.5.3 Miscellaneous tab.....	29
2.2 Technical specifications.....	4	4.5.4 Movement test tab.....	29
<b>3. Getting Started</b> .....	<b>5</b>	4.5.5 Output data tab .....	30
3.1 Unpacking the Corning® Matribot® Bioprinter.....	5	4.5.6 Update tab.....	30
3.2 Contents of the box.....	8	<b>5. LCD Interface</b> .....	<b>31</b>
3.3 Setting up the Corning Matribot Bioprinter .....	8	5.1 Status screen .....	31
3.4 Starting the Corning Matribot Bioprinter for the first time .....	8	5.2 Temperature control .....	31
3.5 Overview of the printhead .....	9	5.3 Attach the syringe to the syringe plunger holder .....	31
3.6 Loading of the syringe .....	10	5.4 Printing using g-code file .....	31
3.7 Mounting of the Thermal Insulator .....	11	<b>6. Maintenance</b> .....	<b>32</b>
3.8 Detaching the Thermal Insulator.....	11	6.1 Maintenance plan.....	32
<b>4. Bioprinting with the Corning Matribot Bioprinter ....</b>	<b>12</b>	6.2 Cleaning or sanitizing the Corning Matribot Bioprinter	32
4.1 Installing Corning DNA Studio.....	12	6.3 Leveling the printbed .....	33
4.2 Connecting the Corning Matribot Bioprinter .....	12	6.4 Tensioning the belts .....	34
4.3 Bioprinting from a 3D model .....	13	6.5 Troubleshooting guide .....	35
4.3.1 Start a Bioprint project.....	13	<b>7. Limited Warranty</b> .....	<b>38</b>
4.3.2 Generate the geometry.....	14	<b>8. Equipment Disposal</b> .....	<b>38</b>
4.3.3 Print surface .....	15		
4.3.4 Printer settings.....	15		
4.3.5 Printhead settings .....	16		
4.3.6 Models settings .....	17		
4.3.7 Layers settings .....	18		
4.3.8 Calibration and Automatic bed-leveling (ABL) .....	19		
4.3.9 Print model .....	20		

## 1. Safety Information

Review the entire manual, before using the Corning® Matribot® Bioprinter. Mishandling of the Corning Matribot Bioprinter can lead to equipment damage and severe injury. The following symbols are used to indicate risk of equipment damage or personal injury:



This symbol indicates risk of injury or equipment damage.



This symbol indicates a heated surface. The Corning Matribot Bioprinter has heated surfaces that may cause personal injury or equipment damage if not treated with care. A physical symbol labels these surfaces on the Corning Matribot Bioprinter.



This symbol indicates the presence of UV light.



This symbol indicates the equipment is sensitive to electrostatic discharge.



This symbol indicates potential finger pinch point hazard.

### 1.1 General safety information

Corning Matribot Bioprinter operators must familiarize themselves with this manual before operation. Failure to do so presents a safety risk to themselves and others around them.

If the Corning Matribot Bioprinter acts in a way that is not described in this manual, turn it off and contact Corning. Use the Corning Matribot Bioprinter for its intended purposes only. Do not modify its instruments, subcomponents, or accessories. Do not open or disassemble the Corning Matribot Bioprinter or attempt any service other than those described in the manual.



Never place your fingers or any part of your body near the machine until all parts have stopped moving. Moving parts can cause injury. Be careful when loading and unloading the print sample.

Use caution when working near the needle. Piercing the operator's skin can occur. Remove the syringe, needle, or nozzle before working on the printbed.

Never clean or service the Corning Matribot Bioprinter while it is on. Always turn off the power and disconnect any external sources of power before cleaning or servicing the Corning Matribot Bioprinter.

Do not print with flammable materials.

Always ensure that equipment is correctly mounted before use. Improperly mounted syringes or surface probes can be dangerous. If any equipment appears damaged, turn off the machine, unplug all external connections and contact Corning before further use.



The Corning Matribot Bioprinter uses UV light for curing. Never look directly at UV light. Never expose skin to UV light. Eye or skin exposure can result in serious personal injury.



The printbed might be hot during and after operation. Never touch heated surfaces when using the heating function. Always let the printbed cool after using the heating function.

The stepper motors might be hot during and after operation. Never touch the motors during operation. Always let the motors cool after operating the device.



The LED curing system might be hot during and after operation. Never touch the LED curing system during operation. Always let the curing system cool after operating the device.

### 1.2 Unpacking, lifting, and carrying

Read how to safely unpack and set up the Corning Matribot Bioprinter in Section 3 of this manual.



The Corning Matribot Bioprinter weight is 33 lbs. (15 kg). Always use a minimum of two people to unpack and move the machine.

### 1.3 Electrical information



Always connect the Corning® Matribot® Bioprinter to a grounded socket, and use the voltage described in the specifications. Improper electrical handling can cause equipment damage and personal injury.

### 1.4 Protective equipment



Always wear gloves and eye protection during bioprinting and UV curing.



Always wear gloves and eye protection while handling hazardous materials, including materials that are toxic, corrosive, or carcinogenic.

Read the material safety data sheets, packing labels, and the manufacturer's or distributor's catalog for all reagents before using the Corning Matribot Bioprinter.

### 1.5 Hazardous materials



Consult material safety data sheets, packaging labels, and the manufacturer's or distributor's catalog for all reagents before handling hazardous dispensing materials, such as corrosive materials. Ensure all operators are informed of the material's characteristics and its compatibility with the dispensing unit. Always use appropriate safety equipment and attire. It is prohibited to use dispensing materials with a flash point of 150°C or lower. If you are unsure of a material's compatibility, contact Corning.

After using ethanol to clean the Corning Matribot Bioprinter, wait at least 60 seconds before bioprinting to ensure that all flammable vapors are removed.

### 1.6 Electrostatic discharge (ESD) protection

The Corning Matribot Bioprinter printbed and printhead are ESD sensitive. Use the following procedures to ensure that no ESD damage is caused to the printbed, printhead, or internal electronics.

#### 1.6.1 Procedures

Review the procedures to follow when using the Corning Matribot Bioprinter printbed and printhead.

#### 1.6.2 Discharging yourself

Always discharge yourself before touching the printbed or printhead of the Corning Matribot Bioprinter using one of the following methods, from most effective to least effective:

1. ESD dissipative wrist strap attached to ESD mat or earth ground.
2. ESD dissipative heel strap on ESD dissipative surface.
3. Discharge body-level ESD through surface connected to earth ground. Laminar flow hoods should have this connection through non-painted and non-anodized surfaces.
4. Wear clothing resistant to building electrostatic charge. Cotton clothing and ESD rated shoes come in multiple forms.

## 2. Specifications

The Corning® Matribot® Bioprinter is equipped with a single, high-accuracy temperature regulated, syringe-based extrusion printhead, heated printbed, and a 405 nm LED curing system for bioprinting of complex human tissue models for 3D cell culture and tissue engineering research. It is a unit for innovators to enter the 3D cell culture and bioprinting fields and start bioprinting living tissue models with ease. It can be used as a standalone unit via the LCD controller, or it can be monitored and controlled via USB-interface to a computer with the use of included software. Corning DNA Studio translates your three-dimensional CAD models into coordinates and instructions for the Corning Matribot Bioprinter to precisely deposit your materials onto a Petri dish, well plate, or other vessel. The bioprinting and biodispersing processes work through the extrusion of a hydrogel biomaterial, such as Corning Matrigel® matrix, Collagen, or any basement membrane matrix combined with human cells in a bottom-up, layer-by-layer fashion until a 3D tissue model is built. Depending on your biomaterial crosslinking or gelation requirements, the bioprinted 3D construct is crosslinked by increasing the temperature of the printbed or using the 405 nm LED curing system.

### 2.1 Product map

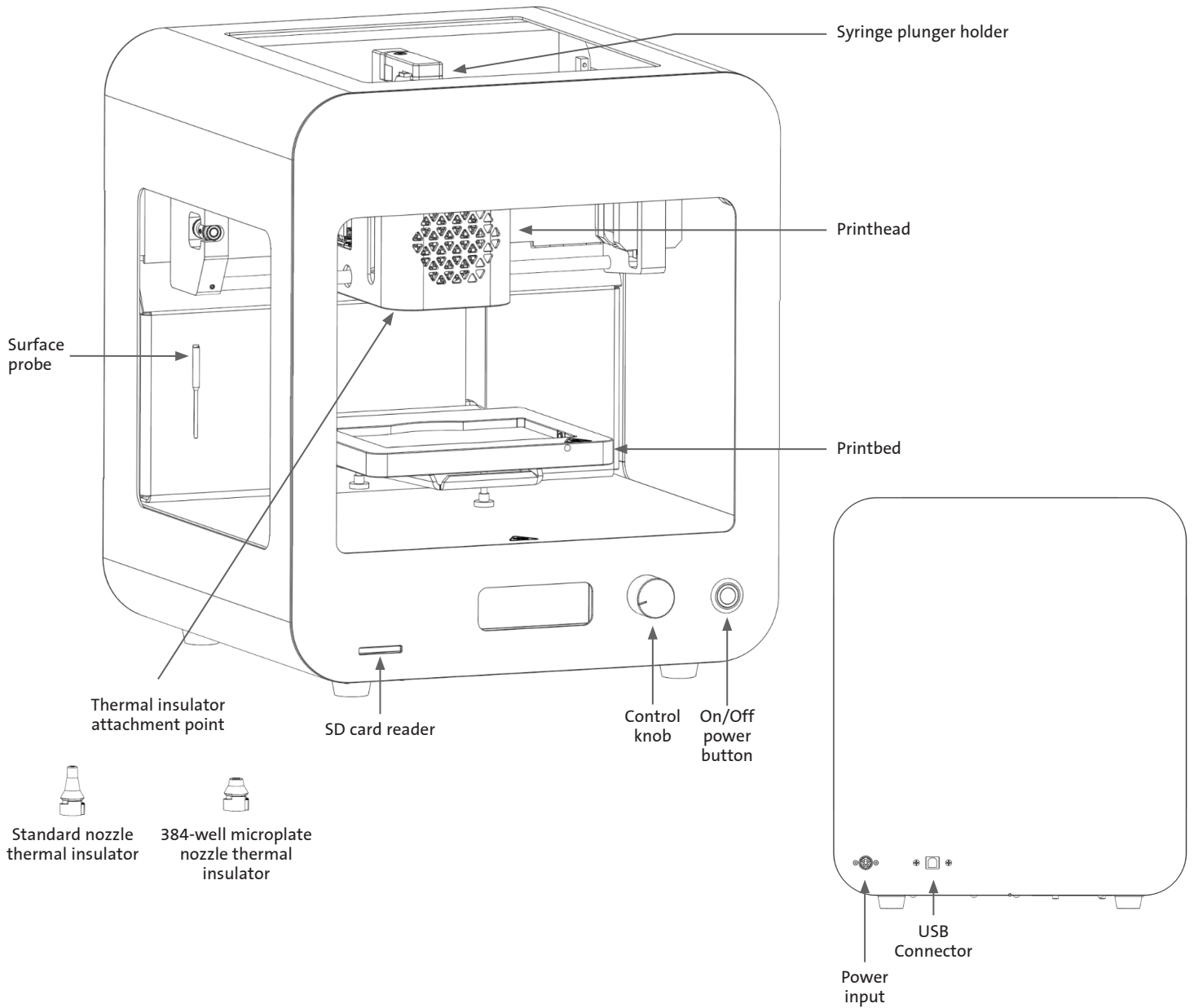

## 2.2 Technical specifications

Printhead volume range	1 $\mu$ L to 2700 $\mu$ L
Minimum volume unit setting	0.1 $\mu$ L
Flow rate range	1 to 100 $\mu$ L/s
Hydrogel viscosity range	1 to 250000 cP [mPa-S]
Build Volume (L x W x H)	5.1 x 3.2 x 2.0 in. (130 x 80 x 50 mm)
UV-curing system	405 nm LED curing system
Calibration options	Manual or automatic
Nozzle length	0.25 in. to 1.5 in. (6.35 mm to 38.1 mm)
Resolution XY	10 $\mu$ m
Resolution Z	10 $\mu$ m
Layer resolution	50 $\mu$ m
Display	Smart LCD controller – 3" LCD
User interface	Integrated LCD display, Corning® DNA Studio
Connectivity	USB
<b>Temperature</b>	
Printbed temperature range	Room temperature to 65°C
Printhead temperature range	0°C to room temperature
Operating temperature range	15°C to 30°C
Storage temperature range	-10°C to 60°C
<b>Software</b>	
Software bundle	Corning DNA Studio
Supported file formats	G-code, STL, OBJ, AMF
Supports	Windows (XP 32 bit/7+) and macOS X (10.6 64 bit/10.7+)
Communication	USB, SD card
<b>Electrical</b>	
Power supply adapter input	100-240 VAC, 50/60 Hz, 160W
Power supply adapter output	24VDC, 6.67A, 160W max.
Corning Matribot Bioprinter input	24VDC, 6.67A
<b>Physical specifications</b>	
Shipping box (L x W x H)	23 x 21.5 x 17 in. (590 x 550 x 430 mm)
System weight	33 lbs. (15 kg)
Shipping weight	44.5 lbs. (20 kg)
Bioprinter outer dimensions (L x W x H)	14.6 x 12.8 x 15 in. (370 x 325 x 380 mm)

### 3. Getting Started

#### 3.1 Unpacking the Corning® Matribot® Bioprinter

Follow these steps to unpack the Corning Matribot Bioprinter.



Do not attempt to unpack the Corning Matribot Bioprinter without reviewing the procedures below. Doing so risks personal injury and equipment damage.

Always use a minimum of two people to unpack and move the Corning Matribot Bioprinter.

The Corning Matribot Bioprinter should never be placed on wet, damp, moist, or humid surfaces.

Do not force or tear anything during the unpacking or setup process as this may irreversibly damage your Corning Matribot Bioprinter.

Position the system to ensure the user has fast access to the power cable or that the system is run through an emergency disconnect when an emergency stop may be required.

The device must be connected to a power outlet with protective grounding.

1. Clear a sturdy table or benchtop and floor space of at least 2 x 3 feet (0.6 x 0.9 meters).
2. Place the box on the floor and open it.
3. Remove the two loose item boxes.



4. Review the contents of the two boxes to ensure that you have received all of the equipment visible below.





5. Remove the top protective shipping foam.

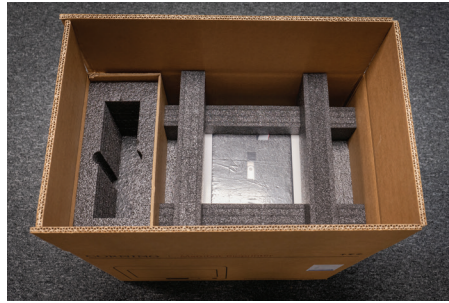

6. Use the Corning® Matribot® Bioprinter frame to grab the device. Be careful not to grab any movable parts or loose components. It is recommended to have 2 people lift from the sides of the frame at the indicated locations. Remove the device out of the box and place it on the table or benchtop.

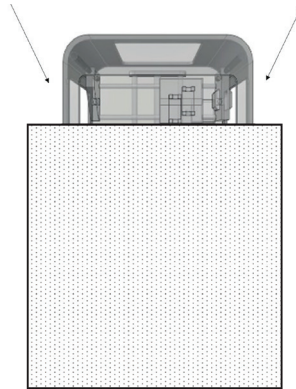

7. Remove the protective plastic bag from the unit.



8. Remove the top inner foam insert as shown. **DO NOT** pull on the printhead cable.





9. Remove the middle inner foam insert as shown.



10. Lift the printbed support located at the back of the printer to release the lower foam insert. Pull the foam insert from the front of the printer to remove as shown below.



11. Take the surface probe out of the electrical supply box and place it inside the device.



12. Refer to the following sections of this manual for start up instructions and support.



13. Keep all of the original packaging materials such as foams, plastic envelopes, and boxes in a safe place. You might need them for packing the instrument in case any transportation is required.

### 3.2 Contents of the box

[1x] Corning® Matribot® Bioprinter

#### Electrical supply box contains:

[1x] 24V Power supply

[1x] Power cord, V-lock, EU, 2m

[1x] Power cord, V-lock, US, 2m

[1x] USB Cable A Male to B Male 1.83m

[1x] SD card, 32GB, SDHC

[1x] Standard nozzle thermal insulator

[1x] 384-well microplate nozzle thermal insulator

[1x] Surface probe

[1x] Toolkit for Preventive Maintenance

#### Consumables box contains:

[10x] 2.7 mL syringes with Corning Start Sacrificial Ink (non-sterile)

[5x] 3 mL syringes, sterile

[1x] High precision conical bioprinting nozzles, 22G (non-sterile), 50 pcs

[1x] High precision conical bioprinting nozzles, 25G (non-sterile), 50 pcs

[1x] High precision conical bioprinting nozzles, 27G (non-sterile), 50 pcs

[1x] Petri dish

### 3.3 Setting up the Corning Matribot Bioprinter

Before connecting the Corning Matribot Bioprinter to a wall socket, ensure that the socket is grounded. Next, connect the Corning Matribot Bioprinter power outlet (see Section 2.1 Product map) to the grounded wall socket with the included 24V power supply and the power cord.

Turn on the Corning Matribot Bioprinter by using the power switch on the front (see Section 2.1 Product map).



Always connect the Corning Matribot Bioprinter to a grounded outlet. Connecting the instrument to an ungrounded outlet can cause equipment damage and personal injury.

### 3.4 Starting the Corning Matribot Bioprinter for the first time

The following steps should be followed the first time the Corning Matribot Bioprinter is used, as well as every time it is moved from one place of operation to another.

- Level the printbed using the screws below it according to the instructions in Section 6.3.
- Set up the bioprinting or droplet dispensing process according to the instructions in Section 4.

### 3.5 Overview of the printhead

Ensure you have correctly mounted print surfaces and bioink syringes before biodispersing.

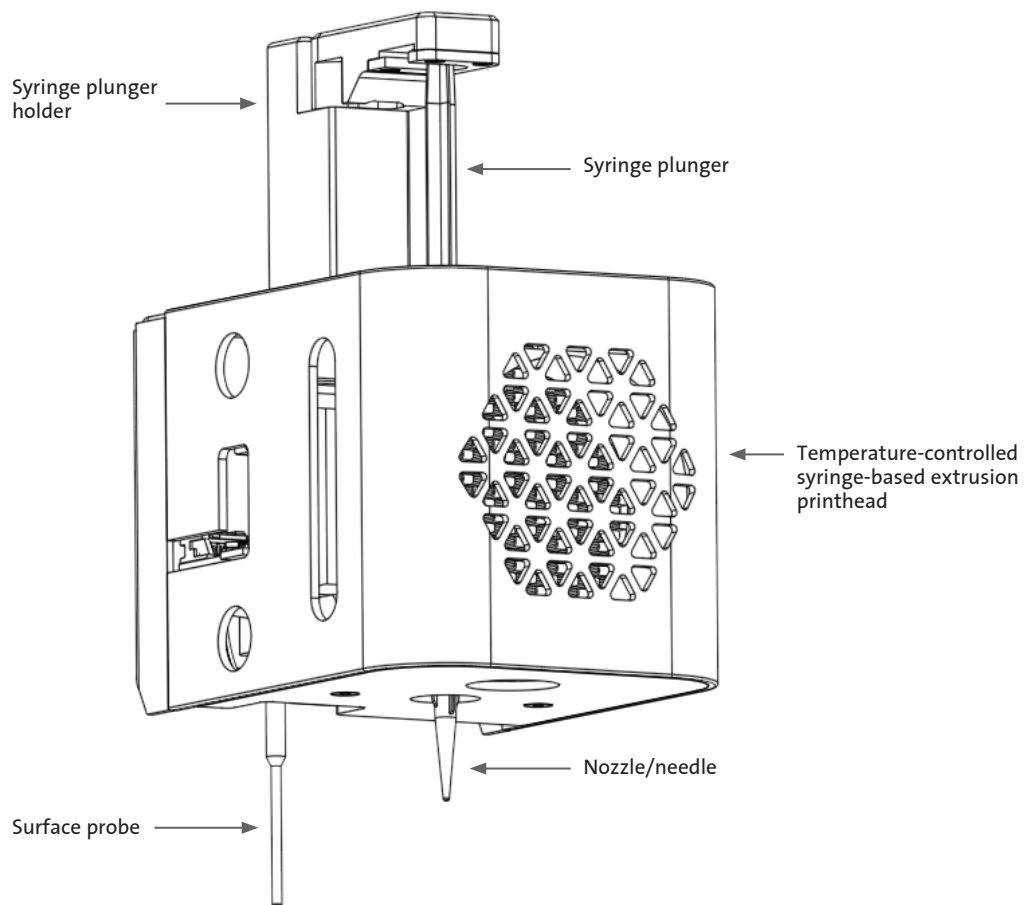

### 3.6 Loading of the syringe

Pre-cool the printhead before loading of the syringe when using temperature-sensitive materials (see Section 4.5.2). Follow the steps below to load the syringe into the printhead.

1. Slide the syringe into the cooling block.
2. Rotate the syringe by the tabs by 90° counterclockwise (looking from the top of the printhead) so that the tabs sit under the top of the block.
3. Adjust the position of the syringe plunger holder by navigating to the Prepare Bioprint menu on the LCD interface and selecting the Raise Plunger function. Using the Extrude Volume Function on the LCD interface, move the syringe plunger holder to match the position of the syringe plunger.
4. Rotate the syringe plunger holder clockwise (looking from the top of the printhead) to securely attach the syringe plunger.

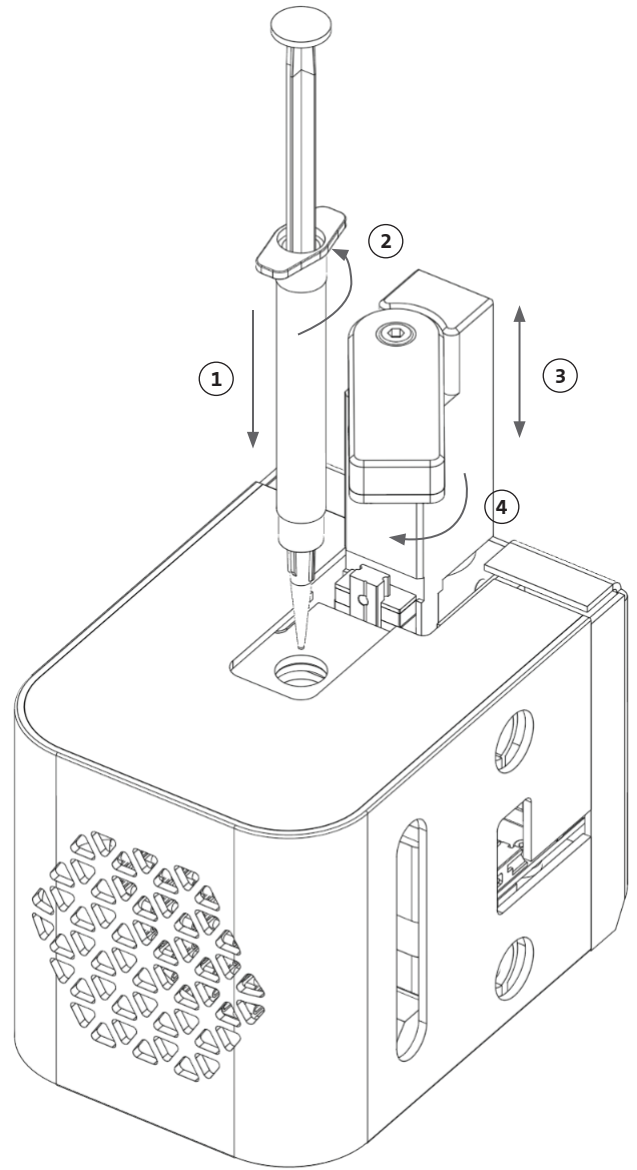

### 3.7 Mounting of the Thermal Insulator

It is important to use the thermal insulator for temperature-sensitive materials to prevent the material from premature gelation.

**NOTE:** It is recommended to attach a thermal insulator prior to loading a syringe.

Follow the steps below to attach the thermal insulator.

**NOTE:** Make sure to use the correct thermal insulator for your application. The 384-well microplate nozzle thermal insulator should be used when dispensing in 384-well microplates. The standard nozzle thermal insulator should be used when dispensing and bioprinting in 6- to 96-well plates and Petri dishes.

1. Slide the thermal insulator into the cooling block.
2. Rotate the thermal insulator **counterclockwise** (looking from the top of the printhead) until the insulator is securely attached.

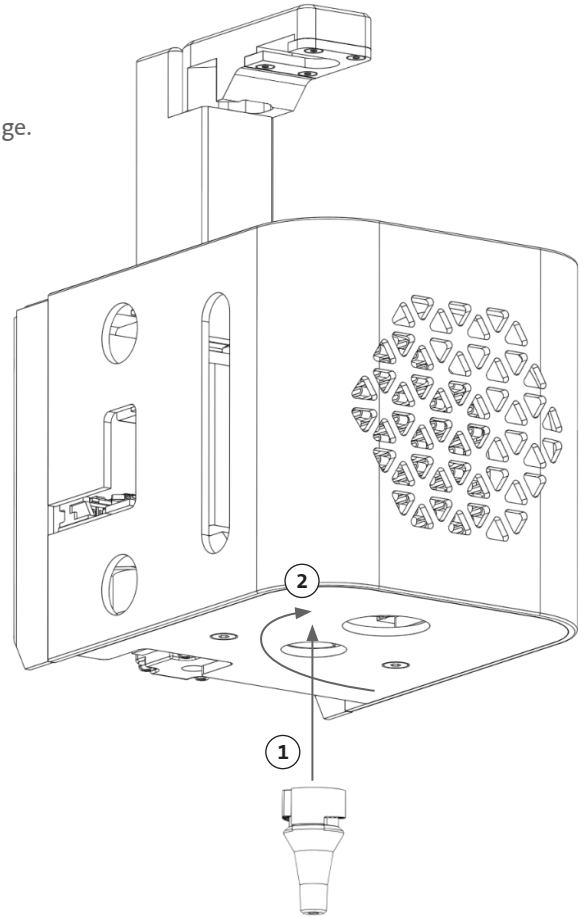

### 3.8 Detaching the Thermal Insulator

Follow the steps below to detach the thermal insulator.

1. Rotate the thermal insulator **clockwise** (looking from the top of the printhead).
2. Slide the thermal insulator out of the cooling block.

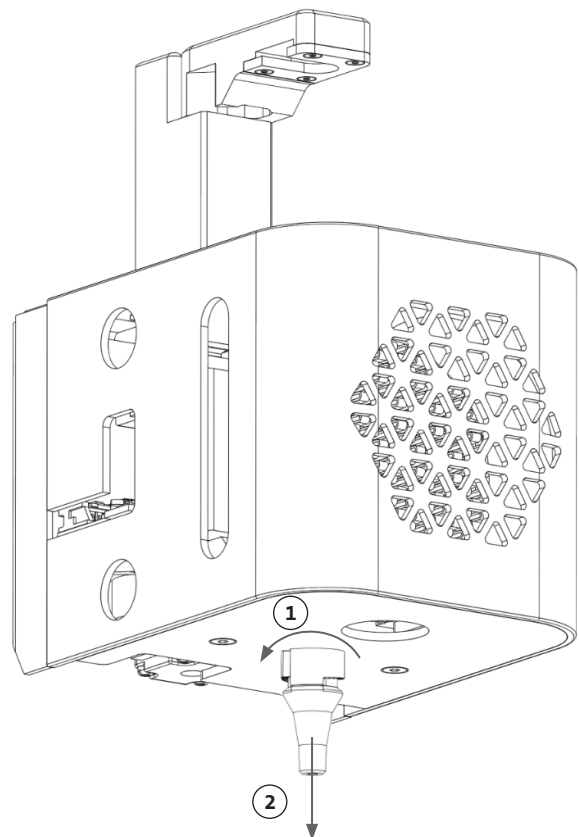

## 4. Bioprinting with the Corning® Matribot® Bioprinter

### 4.1 Installing Corning DNA Studio

Install the latest version of Corning DNA Studio. The latest version of Corning DNA Studio is available at [www.corning.com/matribotguidelines](http://www.corning.com/matribotguidelines).

### 4.2 Connecting the Corning Matribot Bioprinter

To establish connection between the Corning Matribot Bioprinter and Corning DNA Studio follow the steps below.

1. Connect the Corning Matribot Bioprinter to your computer using the included USB cable.
2. If there are no devices listed on the home screen, press the plus (+) button in the bottom right corner.

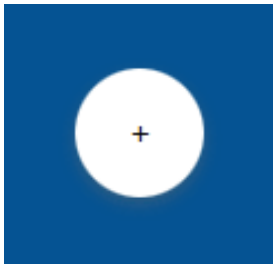

3. Select the correct serial port and press OK.

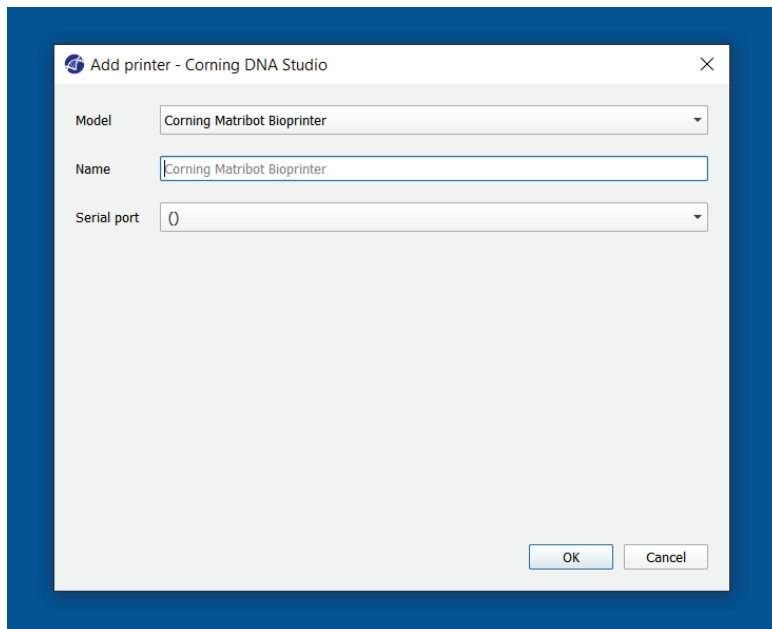

4. Press the connect button to connect to the device.





## 4.3 Bioprinting from a 3D model

### 4.3.1 Start a Bioprint project

Choose the Bioprint option to start a new bioprinting process using a 3D model. Corning® DNA Studio will guide you through the process of setting up your Bioprint.

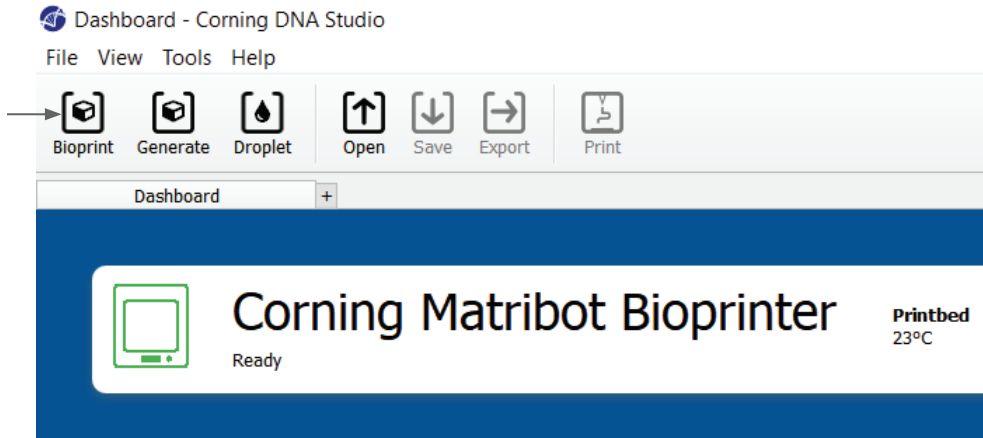

Select the desired supported file types by navigating to the appropriate folder and select the appropriate file.

The included SD card contains a set of files with basic geometries.

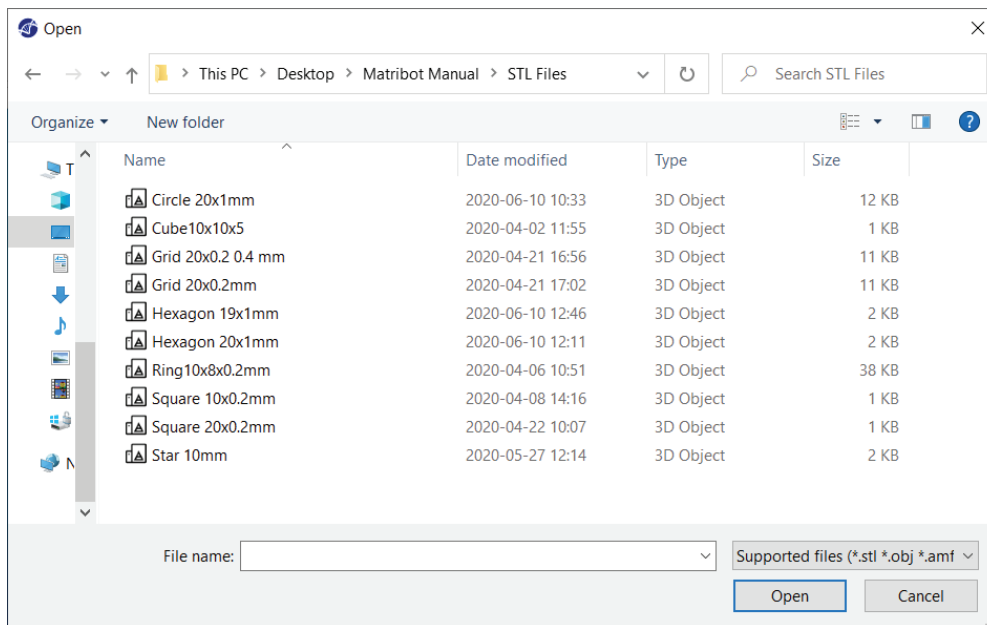

### 4.3.2 Generate the geometry

Instead of selecting the appropriate file, a simple geometry can be generated within Corning® DNA Studio. To generate the geometry, choose the Generate option to start a new bioprinting process using a generated geometry. Corning DNA Studio will guide you through the process of setting up your Bioprint.

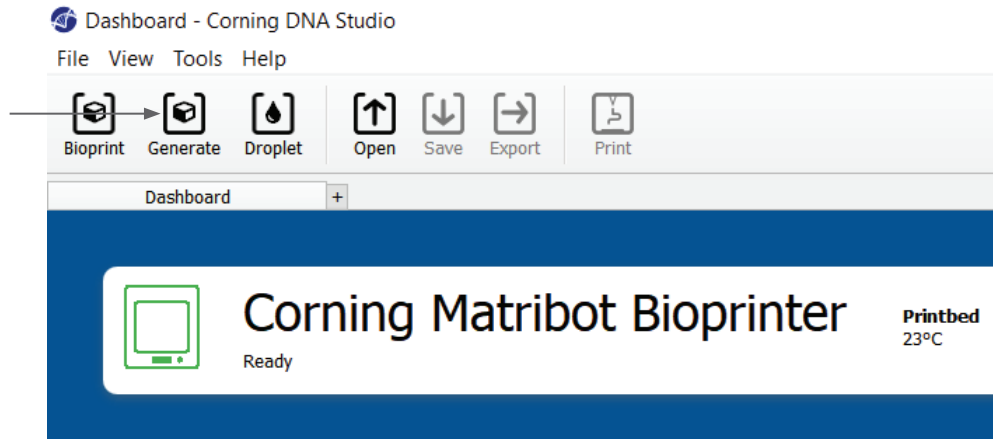

Select the desired geometry and its dimensions.

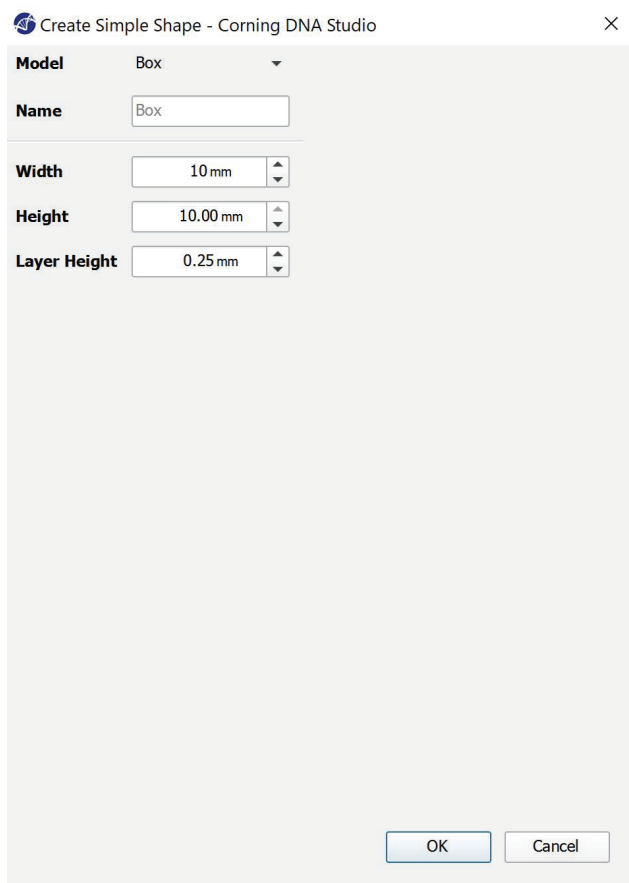

### 4.3.3 Print surface

Select the surface you wish to bioprint on. The Corning® Matribot® Bioprinter can bioprint on a variety of surfaces, including Petri dishes and well plates. Choose the surface you are using and indicate the surface size.

1. Select the type of the surface.
2. For well plates select the vendor of the well plate.
3. For well plates select the number of wells.
4. If selecting a well plate, individual wells can be selected by left, clicking on the desired wells. Ctrl-clicking allows for multiple individual wells to be selected.

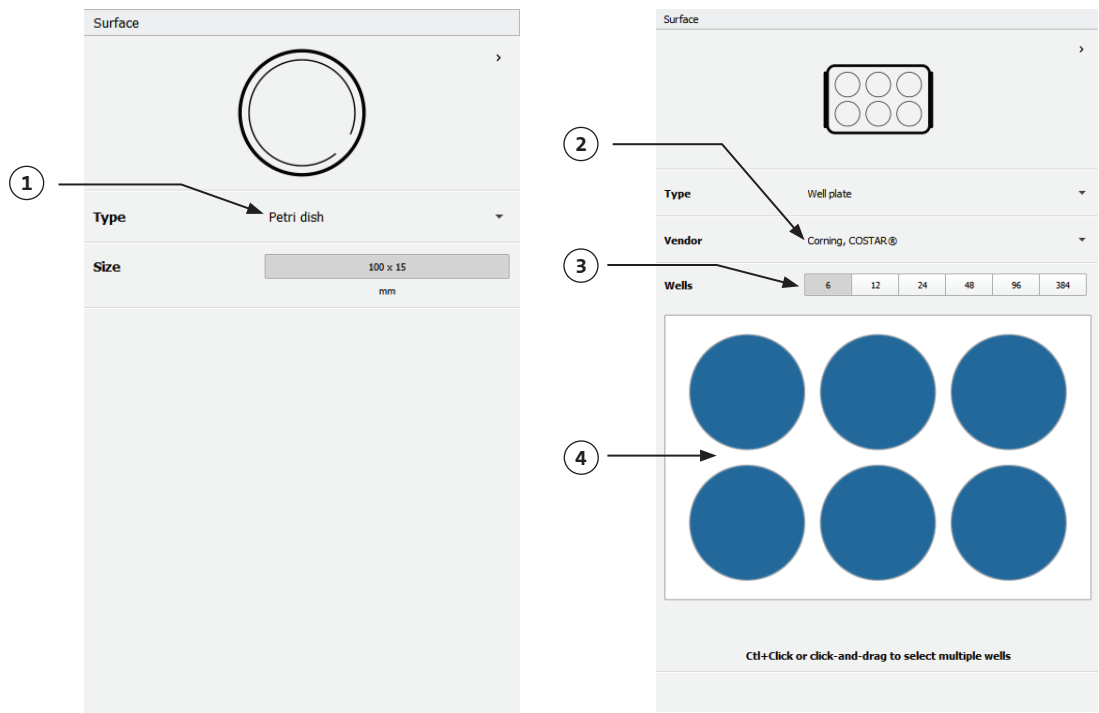

### 4.3.4 Printer settings

Press on the Printer icon on the bottom of the window to move to the next step of the process.

The Corning Matribot Bioprinter is equipped with a heated bed and an LED Photocrosslinking module.

Enable and adjust the Printbed temperature in the Printer settings. Use Temperature control to keep the Printbed at a certain temperature, or turn temperature control off to print at room temperature.

Enable and adjust the Photocrosslinking parameters in the Printer settings. It is recommended to crosslink at the end of each layer.

1. **Printbed temperature:** Activate the printbed temperature control function.
2. **Adjust printbed temperature:** Adjust the temperature of the printbed. When Off, the printbed will be kept at room temperature.
3. **Photocrosslinking:** Activate the LED photocrosslinking module.
4. **Frequency:** Adjust the frequency of photocrosslinking. Either at the end of the bioprinting process or at the end of each layer. It is recommended to crosslink at the end of each layer.
5. **Height:** Adjust the height at which the LED photocrosslinking module will be activated.
6. **Time:** Adjust the exposure time.

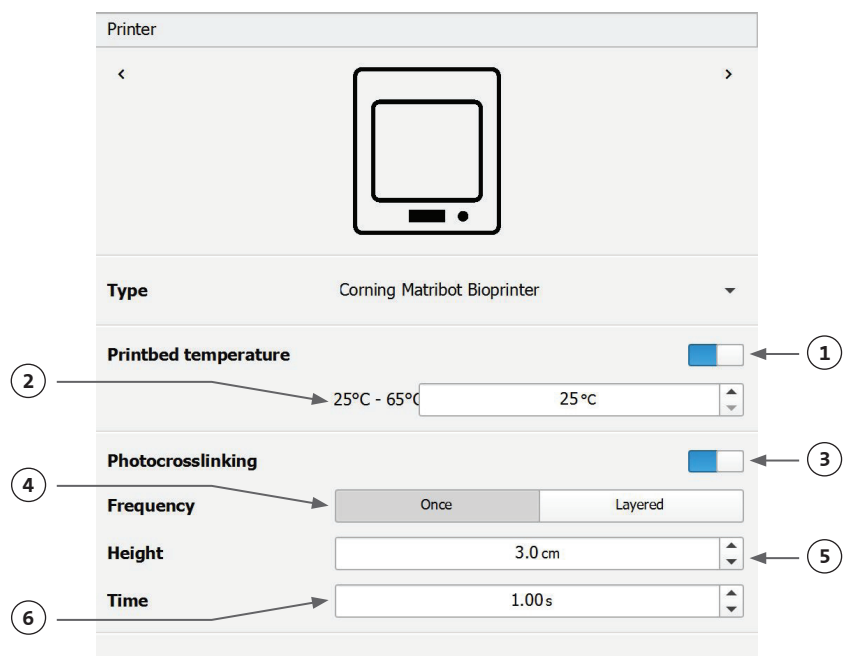

### 4.3.5 Printhead settings

Press on the Printhead icon on the bottom of the window to move to the next step of the process.

This screen enables many of the options and settings for the bioink and print settings.

1. **Bioink:** Select the ink type from the drop-down menu labeled Bioink. This menu has many preset print parameters for common bioink types used in the Corning® Matribot® Bioprinter.

2. **Nozzle:** The size of the nozzle inner diameter. Changing the nozzle size will result in thinner or thicker printed lines.

3. **Speed:** The speed of the printhead during printing moves. Increasing the printing speed will result in a shorter printing time, while decreasing the speed can give higher resolution of the printed structures.

4. Enable temperature control of the printhead.

5. **Temperature:** The temperature of the printhead. Changing the temperature of some materials can alter their viscosity, refer to the protocols for your specific material to determine which temperature the material prints best at. Certain materials require a cool printhead to keep from premature gelation, such as Corning Matrigel® matrix and Collagen.

6. **Preflow volume:** The amount of bioink that is extruded before starting a new filament. Increase the preflow volume if the bioink is not extruding at the starting point of each new filament. Decrease if there is instead an accumulation of bioink at the starting point.

7. **Extrusion rate:** The rate the bioink flows out from the nozzle. Increasing the extrusion rate will increase the flow of the bioink from the nozzle. Decrease if the filament is too thick.

8. **Retract volume:** The volume of bioink which is pulled back up in the nozzle during a non-print move. Increase the retract volume if material continues to flow during non-print moves.

9. **Z-offset:** The height the nozzle tip is moved up from the surface from the calibrated point. Increase the Z-offset if the nozzle is calibrated too close to the surface.

10. **Advanced:** Enable advanced bioprinting parameters.

11. **Extra preflow volume:** The amount of bioink that is extruded at the start of the very first filament. Increase the extra preflow volume if the bioink is not extruded at the starting point, this can happen if the nozzle is not fully primed. Decrease if there is an accumulation of bioink at the starting point.

12. **Infill extrusion multiplier:** A scaling factor of the extrusion rate in the infill compared to the perimeter. Increase the infill extrusion multiplier if the perimeter is thicker than desired while the infill is too thin.

13. **Retract rate:** The speed at which the bioink is retracted back into the nozzle. Increase the retract rate if experiencing a delay in movement due to waiting for the retract move to finish.

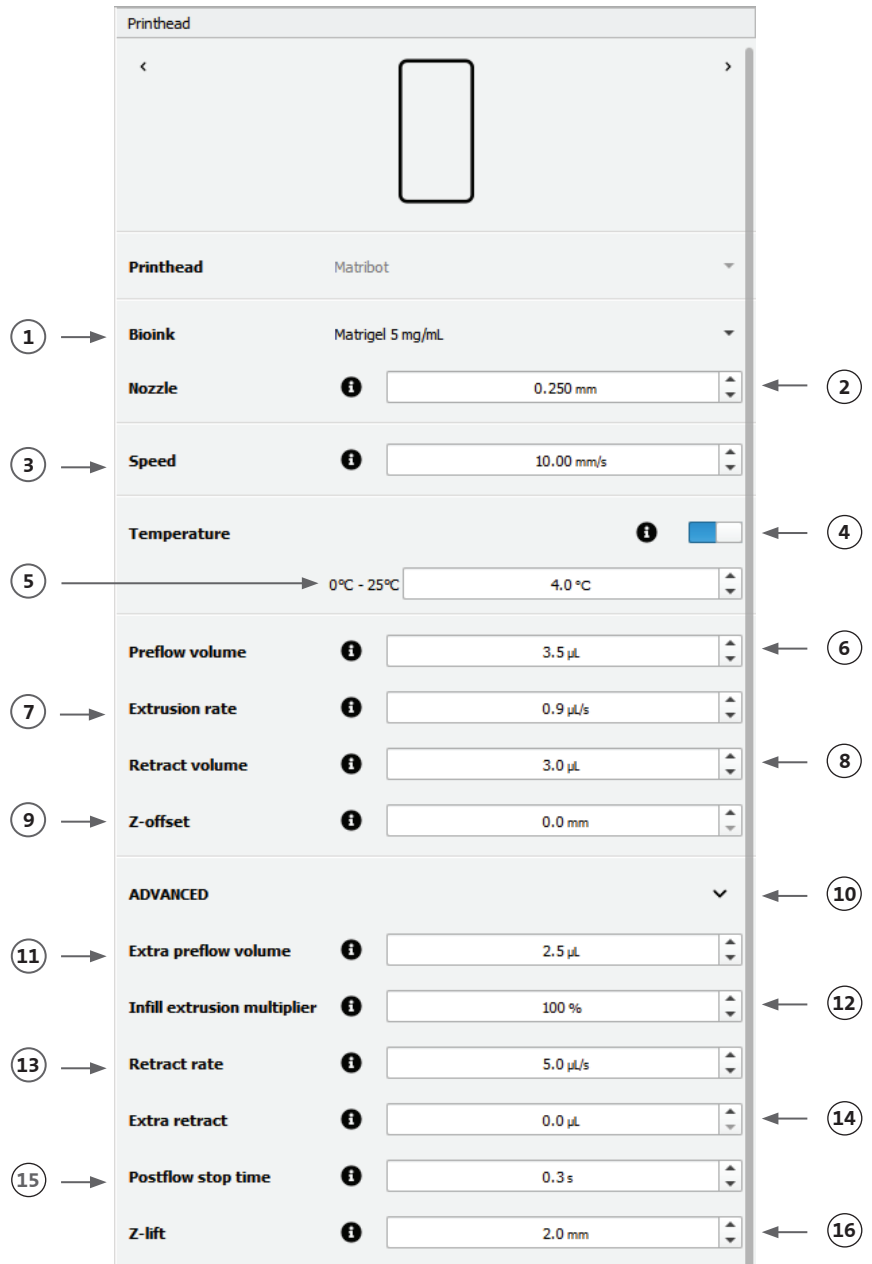

14. **Extra retract:** The volume of bioink retracted back up into the nozzle after the print is finished. If printing with temperature-sensitive materials, increase the extra retract to protect the bioink from heat until the start of a new print.
15. **Postflow stop time:** The time the print movement is delayed after each filament. Increase the postflow stop time if the end of the filament is not complete due to the start of the next move before the bioink is properly extruded.
16. **Z-lift:** The lowering of the printbed when performing non-print moves. Increase the z-lift if the nozzle is dragging in a previously printed filament during a non-print move.

For more detailed information on how parameter selection impacts a print, please refer to the Corning® Matribot® Bioprinter Parameters (CLS-AN-648).

#### 4.3.6 Models settings

Press on the Models icon on the bottom of the window to move to the next step of the process.

This screen enables many of the options and settings for adjusting properties of 3D models. It also allows the user to add multiple 3D models to be printed in one printing session.

1. **Model:** Add multiple models to the same project and select which model is currently being adjusted.
2. **Scale:** Scale the model.
3. **Rotation:** Rotate the model.
4. **Translation:** Translate the model from the default position.

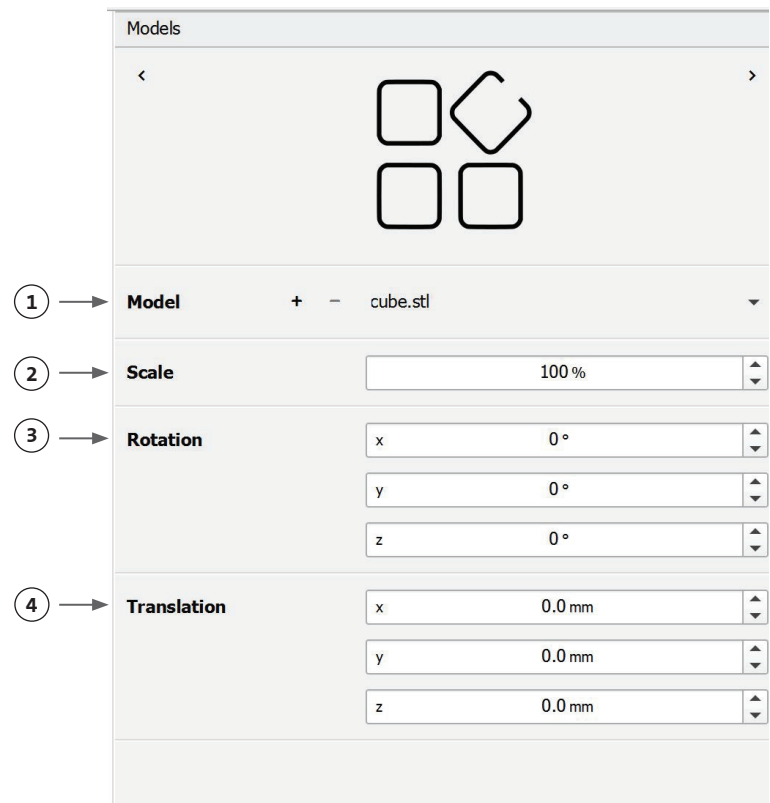

### 4.3.7 Layers settings

Press on the “Layers” icon on the bottom of the window to move to the next step of the process.

This screen enables many of the options and settings for adjusting properties of 3D models. It also allows the user to add multiple 3D models to be printed in one printing session.

1. **Model:** Select which model is currently being modified.
2. **Profile:** Select one of the saved layer profiles or choose to create a new one.
3. **Perimeter:** Activate or deactivate the perimeter.
4. **Infill:** Activate or deactivate the infill.
5. **Pattern:** Tap to choose infill pattern.
6. **Density:** Indicate how dense the model should be.
7. **First layer height:** Specify the thickness of the first layer in percentage of layer height. Corning advises to set the first layer height at 60% to 100% of layer height.
8. **Layer height:** Specify the thickness of each layer in mm. Corning advises to set the layer height at 80% to 100% of nozzle diameter. First layer height can vary.
9. **Number of layers:** Select the number of layers.

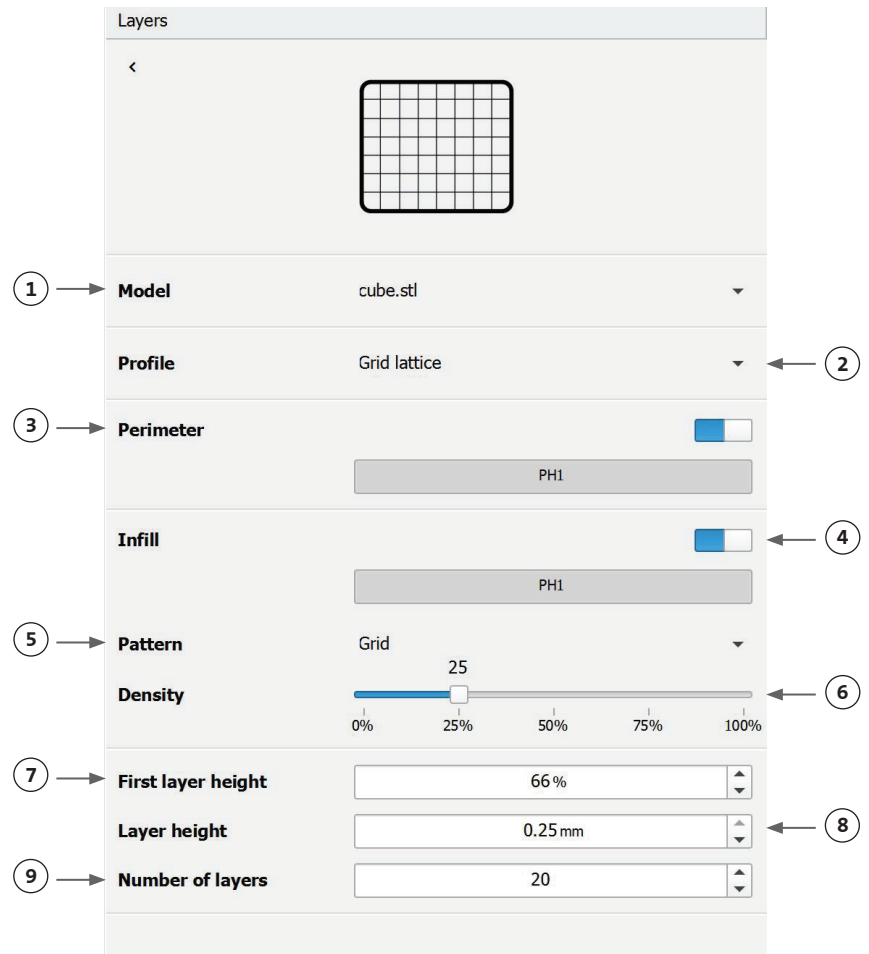

Modify options to define the 3D model’s layers and how the Corning® Matribot® Bioprinter should bioprint the selected model. Use the predefined settings or create custom settings. Descriptions of the infill pattern options are included below.

- **Grid pattern:** Suitable infill for tissue constructs with isotropic mechanical characteristics. This infill pattern is consistent across adjacent layers, resulting in solid walls between the pores and good compressive strength. This pattern is most applicable for tissues such as bone and cartilage. It can also generate constructs with porosity to allow diffusion of nutrients or filling with other bioinks or materials.
- **Honeycomb pattern:** Suitable for constructs with isotropic mechanical characteristics. This infill pattern is consistent across adjacent layers, resulting in solid walls between the neighboring pores with good compressive strength. This pattern is most applicable for tissues such as bone and cartilage. This pattern can also generate constructs that contain porosity to allow diffusion of nutrients or filling with other bioinks or materials.
- **Rectilinear pattern:** Suitable infill for tissue constructs with isotropic mechanical characteristics. This pattern is most applicable for tissues such as skin, fascia, and cartilage. This infill pattern changes the fill angle by 90 degrees based on the layer.
- **Linear pattern:** Similar to the rectilinear pattern, except shifted by 45 degrees instead of 90 degrees from layer to layer. This pattern is suitable for fibers and striated tissues. It can also generate constructs that contain porosity to allow diffusion of nutrients or filling with other bioinks or materials.
- **Concentric pattern:** Suitable for irregular shapes and circular objects. The infill mimics the shape of the outer walls, creating concentric ripples. It is ideal for high infills and complex geometries, and it ensures that the structure is filled in. **NOTE:** There is minimal crossing of filaments, which might be detrimental for the structural integrity of the construct.
- **Gyroid pattern:** Consists of wave-like patterns which are suitable to use in applications that require elasticity. The pattern is similar in structure and orientation to the rectilinear pattern. This is most applicable for tissues such as skin, ligament, muscle, tendon, and others where elasticity is important.



### 4.3.8 Calibration and Automatic bed-leveling (ABL)

If you are satisfied with the selected settings, press Print on the top bar of the window.

Make sure the correct device is selected and press OK to continue.

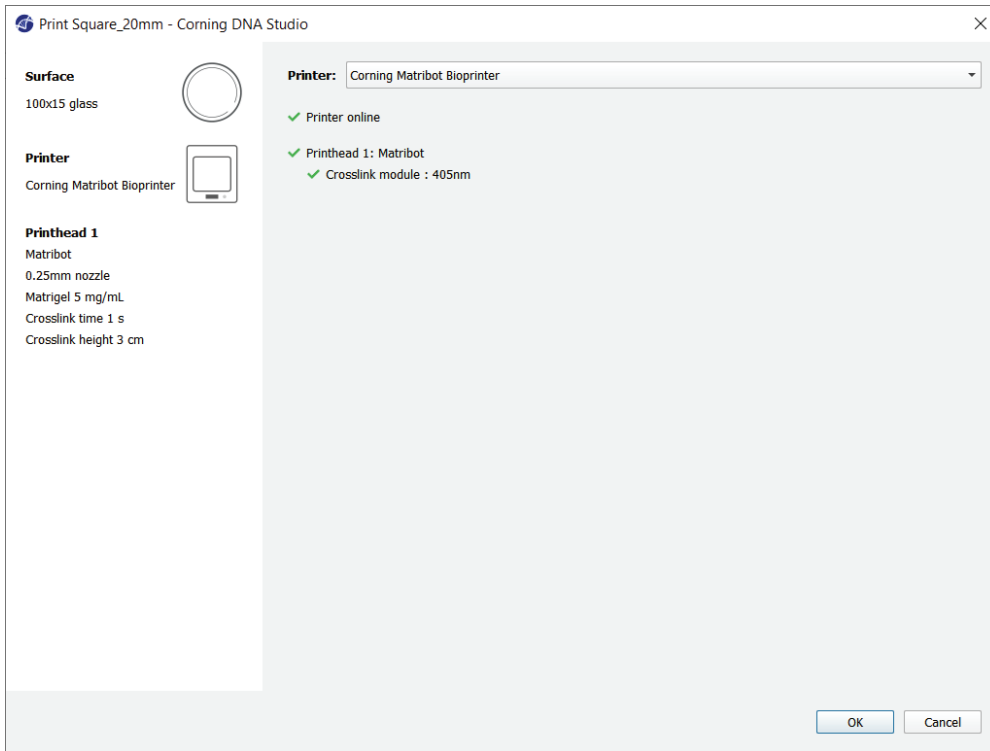

Press Calibrate to calibrate the printhead.

There are three calibration options: Automatic calibration, Automatic bed-leveling (ABL), and Manual calibration.

- Automatic calibration is the most versatile calibration method. Corning recommends using Automatic calibration in most cases. To perform automatic calibration, press the Automatic calibration button, and follow the instructions on the screen.
- Automatic bed-leveling probes the bed at three points to enable bed-leveling compensation. It uses a matrix to compensate for tilt in the bed or print surface. Corning recommends using Automatic bed-leveling if the layer height is visually different on one side of the bed than on the other side when inspecting a 3D printed construct. Automatic bed-leveling will initially appear disabled and is only enabled after automatic or manual calibration is performed.
- To perform the manual calibration, press the Manual calibration button, and navigate the manual calibration settings to calibrate the printhead. Using the buttons on the screen, place the nozzle as close to the printing surface as possible without the nozzle touching the surface. Corning recommends using Manual calibration to adjust position in X and Y axes or when dispensing droplets in 96- and 384-well microplates.

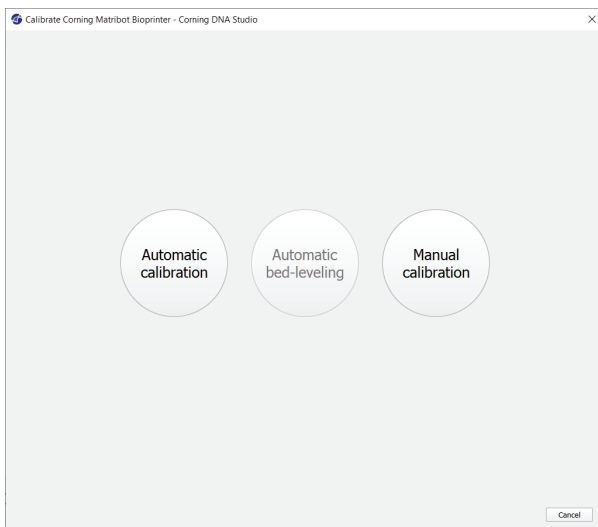

1. Select manual calibration mode. The default mode is recommended.
2. Plate layout: 'X' marks the location that the user needs to position the nozzle in.
3. Z axis command: Controls the position of the printbed along the Z axis.
4. X, Y axis command: Controls the position of the printhead along the X and Y axis. The central button moves the printhead and printbed to the Home position.
5. Step size: Select the step size for X, Y, and Z axis movements.
6. Calibrate: Register the calibration settings.

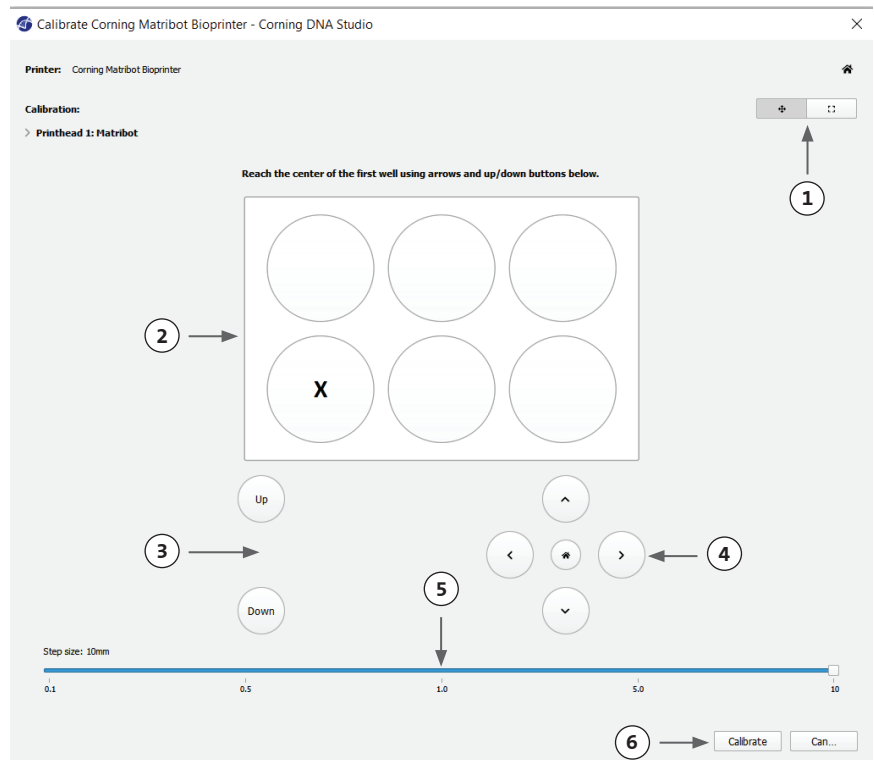

#### 4.3.9 Print model

This screen, which appears on the right side of the software window, summarizes the bioprinting process. You can monitor the activity of the device while printing. In addition, you can change the parameters such as printbed temperature and printhead temperature.

1. Printbed temperature: Allows you to activate/deactivate, change, and monitor the temperature of the printbed.
2. Temperature: Allows you to activate/deactivate, change, and monitor the temperature of the printhead.
3. Printing parameters.
4. Extrusion: Extrude low volumes of material before starting the printing process to prime the nozzle.

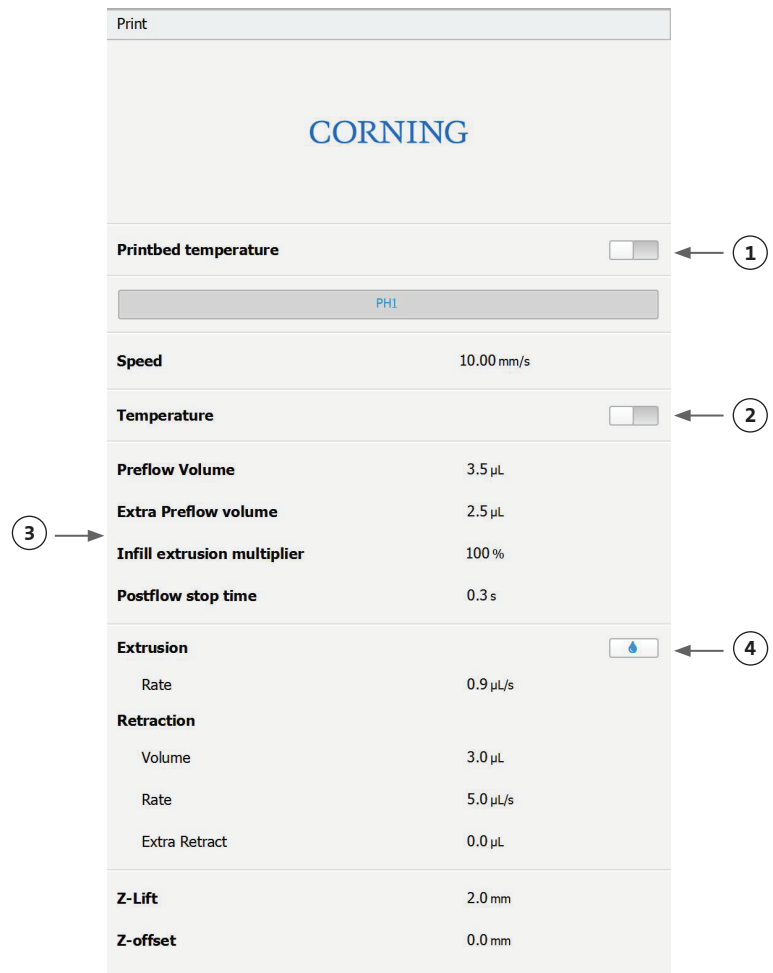

Prior to printing, it is recommended to prime the nozzle. This can be done through the Extrusion button on the Printer model screen or through the Extrude Volume function in the Prepare Bioprint section of the LCD interface on the bioprinter. Press Start to start the bioprinting process.

You can pause printing at any point. After pausing, you can resume or cancel printing.

1. Progress indicator: Displays progress of the bioprinting process as a percentage (%). This is calculated by considering the total number of layers to be printed and the layer which is being currently printed.
2. Pause or resume: Tap to pause the bioprinting process. When the process is paused, tap to resume the bioprinting process.
3. Stop: Tap to stop the bioprinting process. You can restart a print over again after pressing Stop to cancel it.



## 4.4 Biodispensing droplets

### 4.4.1 Start a Droplet project

Choose the Droplet option to start a new droplet dispensing process.

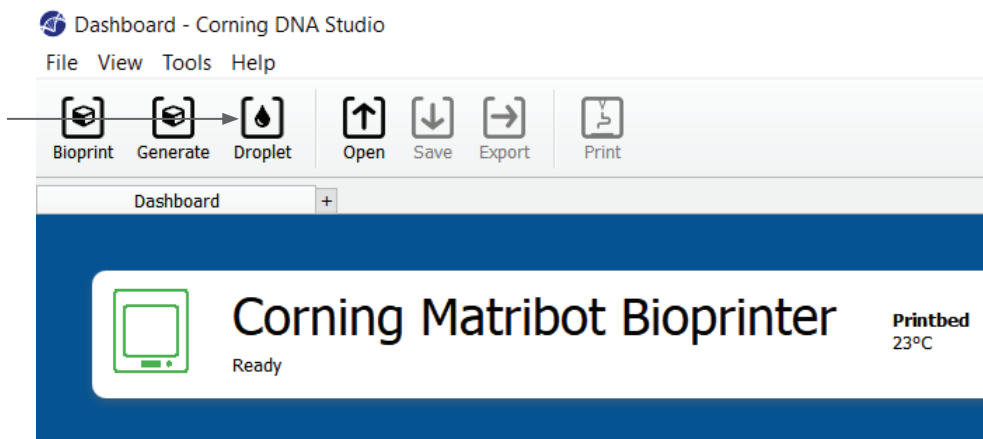

#### 4.4.2 Print surface

Select the surface you wish to dispense droplets on. The Corning® Matribot® Bioprinter can dispense droplets on a variety of surfaces, including Petri dishes and well plates. Choose the surface you are using and indicate the surface size. Besides dispensing single droplets, the Corning Matribot Bioprinter can dispense droplet arrays.

1. Select the type of surface.
2. For well plates, select the vendor of the well plate.
3. For well plates, select the number of wells.
4. If selecting a well plate, individual wells can be selected by left-clicking on the desired wells. Ctrl-clicking allows for multiple individual wells to be selected.
5. Activate the droplet array feature.
6. Select the pattern for the droplet array feature.
7. If the droplet array feature is activated, individual droplets can be selected by left clicking on the desired droplets. Ctrl-clicking allows for multiple individual droplets to be selected.

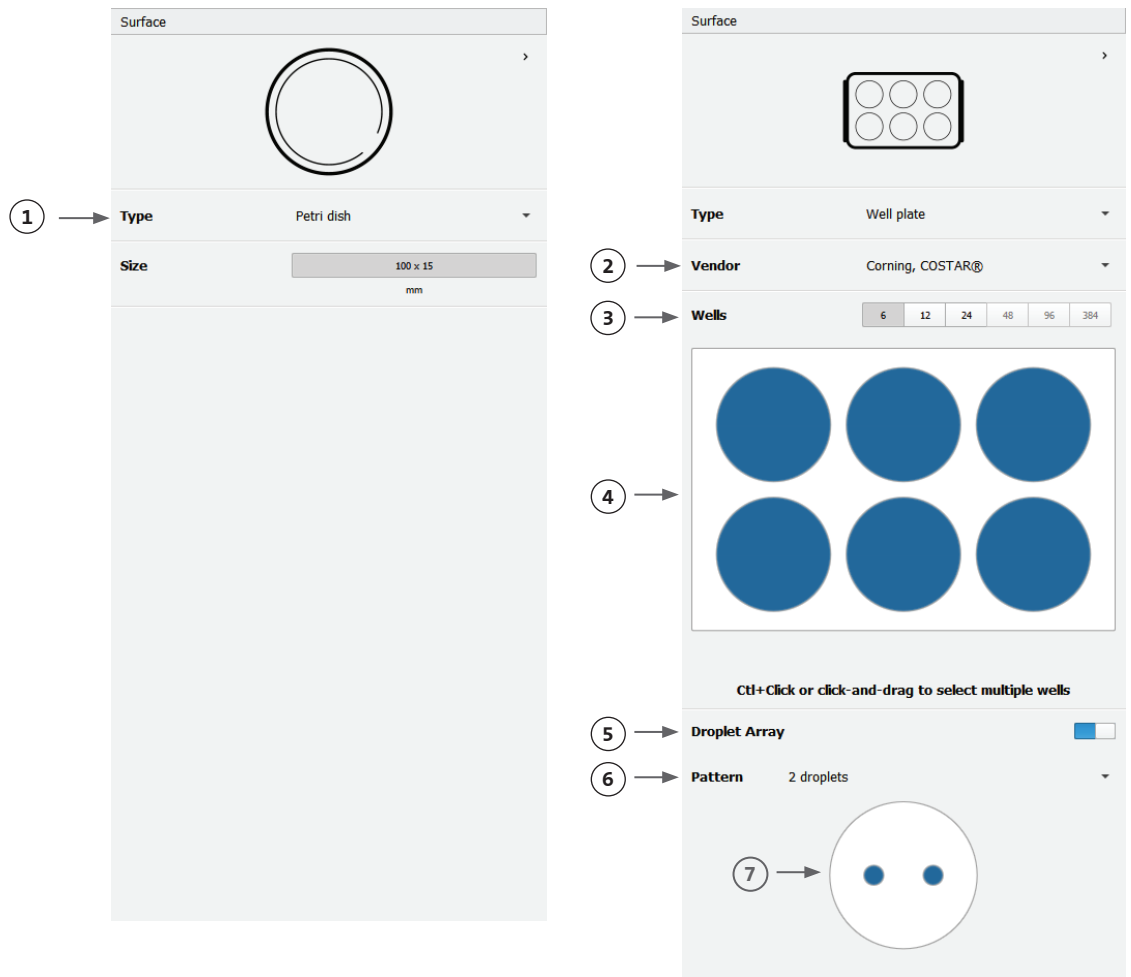

### 4.4.3 Printer settings

Press on the “Printer” icon on the bottom of the window to move to the next step of the process.

The Corning® Matribot® Bioprinter is equipped with a heated bed and an LED photocrosslinking module.

Enable and adjust the printbed temperature in the Printer settings. Use temperature control to keep the printbed at a certain temperature, or turn temperature control Off to print at room temperature.

Enable and adjust the photocrosslinking parameters in the Printer settings.

1. Printbed temperature: Use this to activate the printbed temperature control function.
2. Adjust printbed temperature: Adjust the temperature of the printbed. When Off, the printbed will be kept at room temperature.
3. Photocrosslinking: Use this to activate the LED photocrosslinking module.
4. Height: Adjust the height at which the LED photocrosslinking module will be activated.
5. Time: Adjust the exposure time.

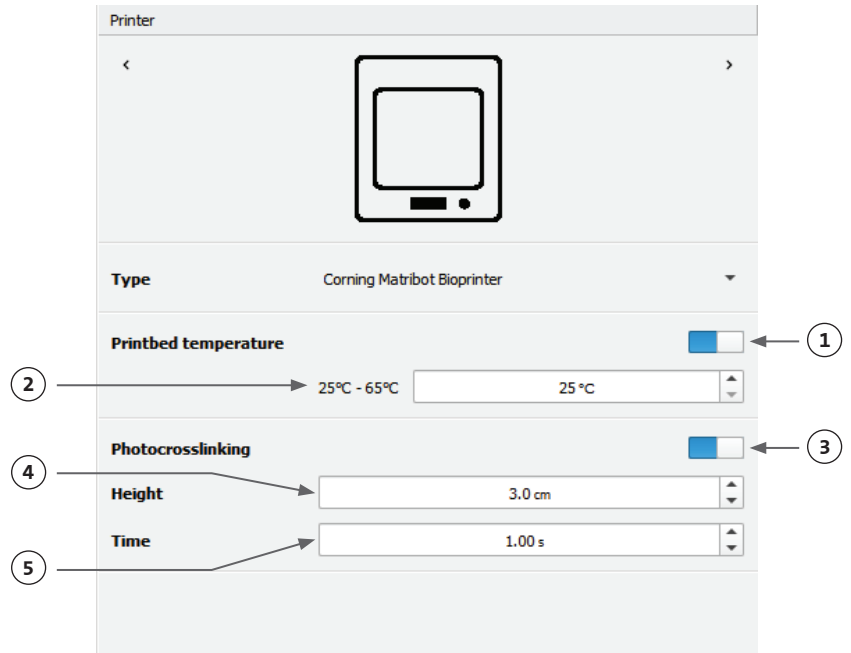

#### 4.4.4 Printhead settings

Press on the “Printhead” icon on the bottom of the window to move to the next step of the process.

This screen enables many of the options and settings for the bioink and print settings.

1. Bioink: Select the ink type and concentration from the drop-down menu labeled ‘Bioink’. This menu has many preset print parameters for common bioink types used in the Corning® Matribot® Bioprinter.
2. Enable temperature control of the printhead.
3. Temperature: The temperature of the printhead. Changing the temperature of some materials can alter their viscosity, check which temperature the material prints best at. Certain materials require a cool printhead to keep from premature gelation, such as Corning Matrigel® matrix and Collagen.
4. Extrusion rate: The rate the bioink flows out from the nozzle. Increasing the extrusion rate will increase the flow of the bioink from the nozzle.
5. Extrusion volume: The volume of the bioink which is extruded when dispensing a droplet.
6. Retract volume: The volume of bioink which is pulled back up in the nozzle during a non-print move. Increase the retract volume and extrusion volume if droplets do not detach in some wells.
7. Droplet volume: The volume of the droplet.
8. Z-offset: The height the nozzle tip is above the calibrated point of surface. Increase the Z-offset if the nozzle is calibrated too close to the surface.
9. Enable advanced bioprinting parameters.
10. Extra preflow volume: The amount of bioink that is extruded at the start of the very first droplet. Increase the extra preflow volume if the bioink is not extruded at the starting point, which can happen if the nozzle is not fully primed. Decrease if there is an accumulation of bioink in the first droplet.
11. Retract rate: The speed at which the bioink is retracted back into the nozzle. Increase the retract rate if experiencing a delay in movement due to waiting for the retract move to finish.
12. Postflow stop time: The time the printhead movement is delayed after each droplet.
13. Z-lift between wells: The lowering of the printbed when the nozzle moves to the next well.

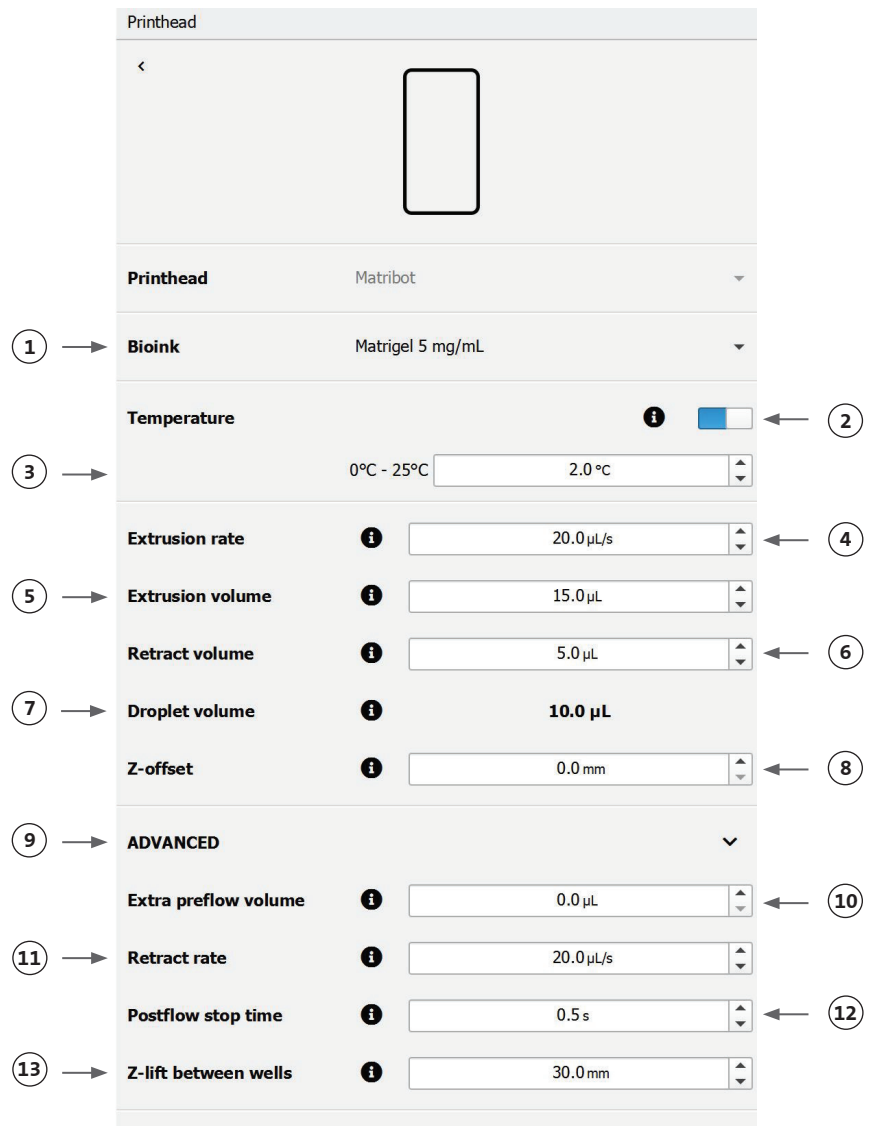

For more detailed information on how parameter selection impacts a print, please refer to the Corning Matribot Bioprinter Parameters (CLS-AN-648).



#### 4.4.5 Calibration and Automatic bed-leveling (ABL)

Once all printer settings are selected, press Print on the top bar of the window.

Make sure the correct device is selected, and press OK to continue.

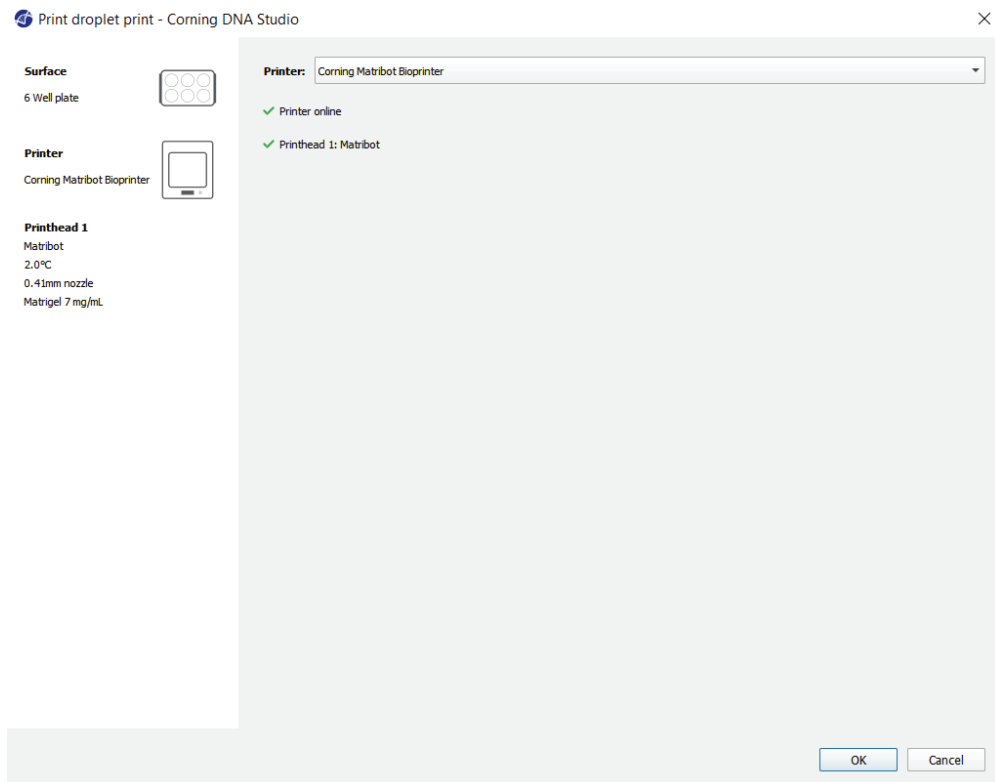

Press Calibrate to calibrate the printhead. There are three calibration options: Automatic calibration, Automatic bed-leveling (ABL) and Manual calibration.

- Automatic calibration is the most versatile calibration method. Corning recommends using Automatic calibration in most cases. To perform automatic calibration, press the Automatic calibration button, and follow the instructions on the screen.
- Automatic bed-leveling probes the bed at three points to enable bed-leveling compensation. It uses a matrix to compensate for tilt in the bed or print surface. Corning recommends using Automatic bed-leveling if the layer height is visually different on one side of the bed than on the other side when inspecting a 3D printed construct. Automatic bed-leveling will initially appear disabled and is only enabled after automatic or manual calibration is performed.
- To perform the manual calibration, press the Manual calibration button, and navigate the manual calibration settings to calibrate the printhead. Using the buttons on the screen, place the nozzle as close to the printing surface as possible without the nozzle touching the surface. Corning recommends using Manual calibration to adjust position in X and Y axes or when dispensing droplets in 96- and 384-well microplates.

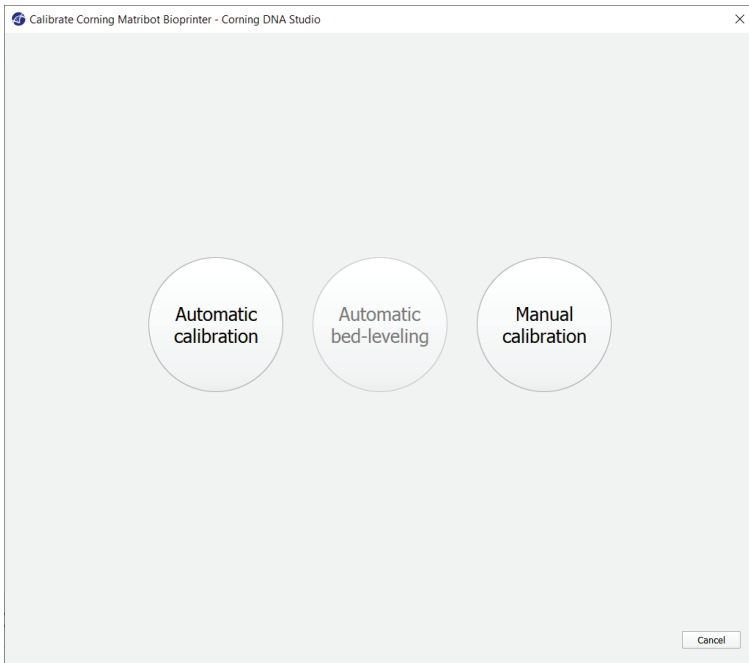

1. Select manual calibration mode. The default mode is recommended.
2. Plate layout: 'X' marks the location that the user needs to position the nozzle in.
3. Z axis command: Controls the position of the printbed along the Z axis.
4. X, Y axis command: Controls the position of the printhead along the X and Y axis. The central button moves the printhead and printbed to the Home position.
5. Step size: Select the step size for X, Y, and Z axis movements.
6. Calibrate: Register the calibration settings.

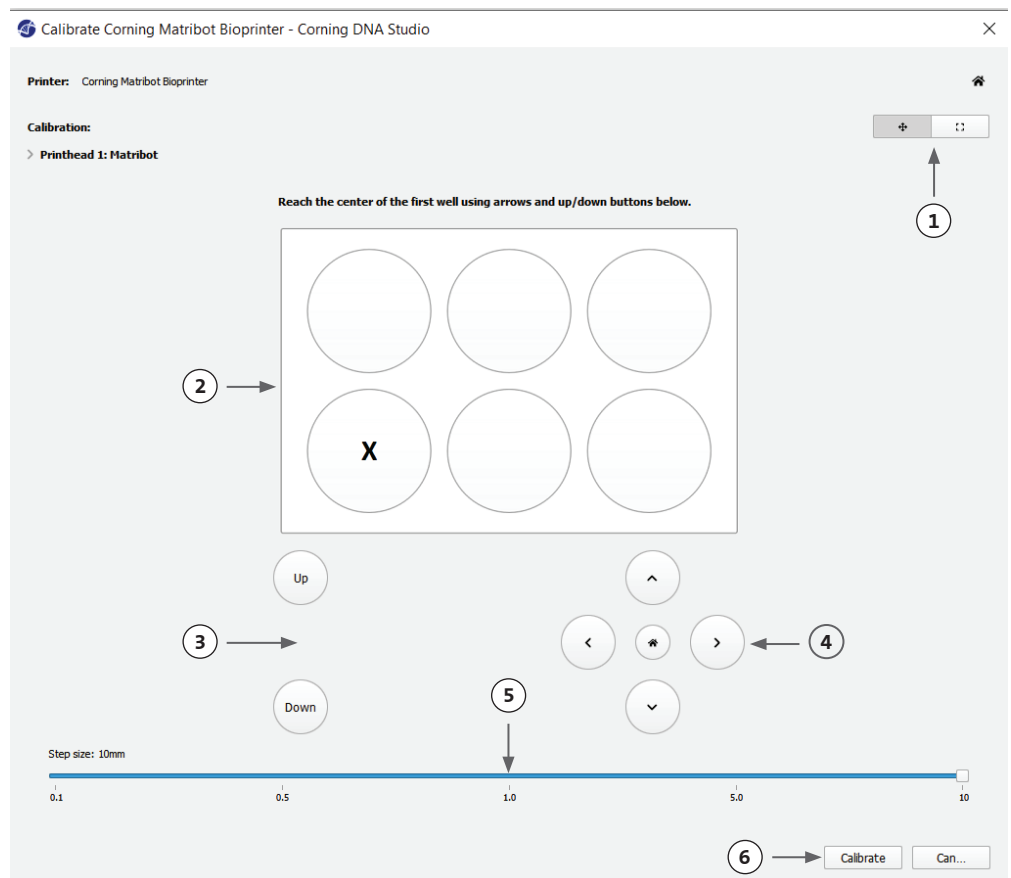

#### 4.4.6 Print model

This screen summarizes the droplet dispensing process. You can monitor the activity of the device while dispensing. In addition, you can change the parameters such as printbed temperature and printhead temperature.

1. Printbed temperature: Allows you to activate/deactivate, change, and monitor the temperature of the printbed.
2. Temperature: Allows you to activate/deactivate, change, and monitor the temperature of the printhead.
3. Dispensing parameters.
4. Extrusion: Extrude low volumes of material before starting the printing process to prime the nozzle.

Section	Parameter	Value
Printbed temperature	Current	21 °C
	Target	25 °C
Temperature	Current	12.6 °C
	Target	2.0 °C
Dispensing parameters	Postflow stop time	0.5 s
	Extrusion	
Extrusion	Rate	20.0 µL/s
	Volume	15.0 µL
Retraction	Volume	5.0 µL
	Rate	20.0 µL/s
Z-offset		0.0 mm

It is recommended to prime the nozzle prior to printing. This can be done through the Extrusion button on the Printer model screen or through the Extrude Volume Function in the Prepare Bioprint section of the LCD interface on the bioprinter. Press Start to start the dispensing process.

You can pause the process at any point. After pausing, you can resume or cancel dispensing.

Corning Matribot Bioprinter

Printing... 12%

Pause Stop

1. Progress indicator: Displays progress of the dispensing process as a percentage (%). This is calculated by considering the total number of droplets to be dispensed and the droplet which is being currently dispensed.
2. Pause or resume: Tap to pause the bioprinting process. When the process is paused, tap to resume the bioprinting process.
3. Stop: Tap to stop the bioprinting process. You can restart a print over again after pressing stop to cancel it.

## 4.5 Utilities

To access the Utilities section, select Tools from the top bar of the software window and choose Utilities.

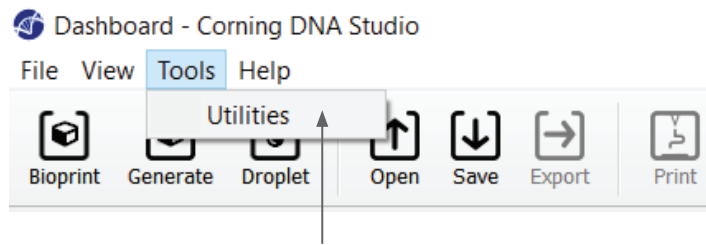

### 4.5.1 Extrusion tab

Use this tab to extrude the bioink, prime the nozzle, or retract the plunger.

1. Extrusion: Set the extrusion rate.
2. Dispense the bioink by pressing and holding the button.
3. Retract the syringe plunger holder by pressing the button.

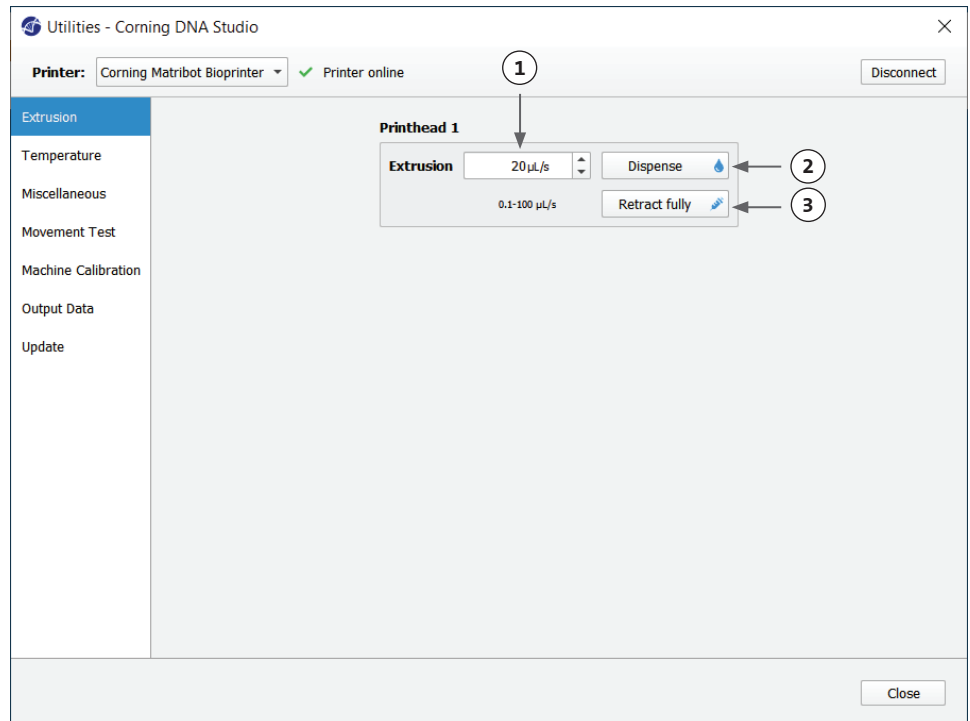

### 4.5.2 Temperature tab

Use the Temperature tab to adjust the temperature control settings. Those setting will be overwritten by the setting in droplet or bioprint projects.

1. Activate temperature control of the printhead.
2. Printhead temperature: Set the temperature of the printhead.
3. Activate temperature control of the printbed.
4. Printbed temperature: Set the temperature of the printbed.

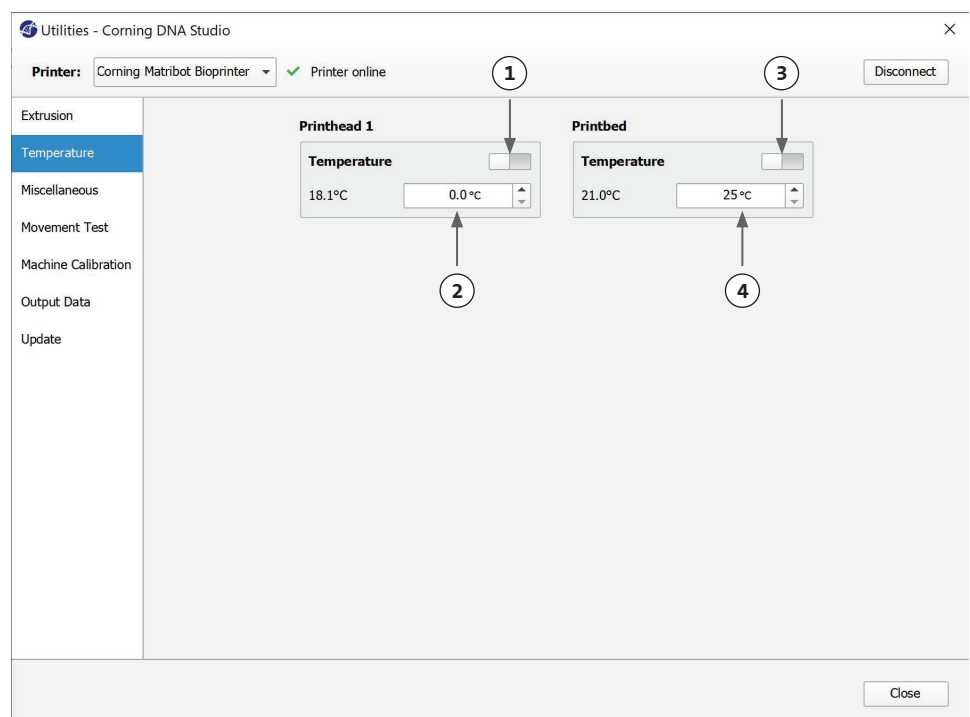

### 4.5.3 Miscellaneous tab

Use this tab to turn On/Off chamber lights.

1. Turn On/Off chamber lights.  
Consider using when working with photosensitive materials.

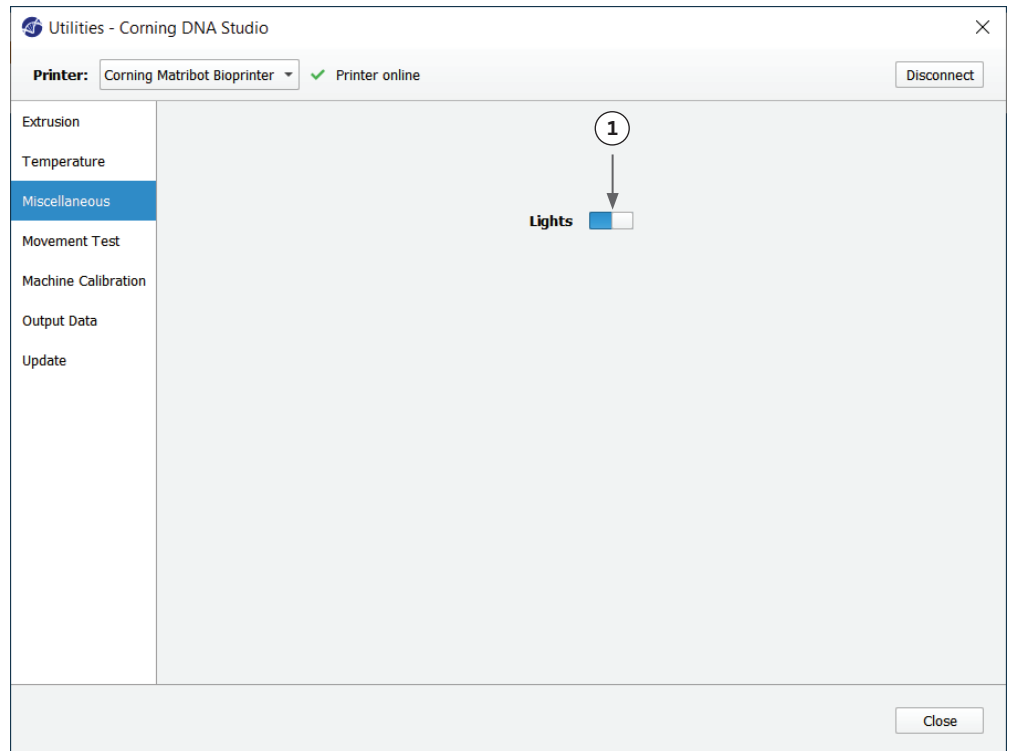

### 4.5.4 Movement test tab

Use this tab to test the movement of the printhead and the printed bed.

1. Z axis command: Controls the position of the printbed along the Z axis.
2. X, Y axis command: Controls the position of the printhead and the surface probe along the X and Y axis. The central button moves the printhead and printbed to the Home position.
3. Select the step size for X, Y, and Z axis movements.

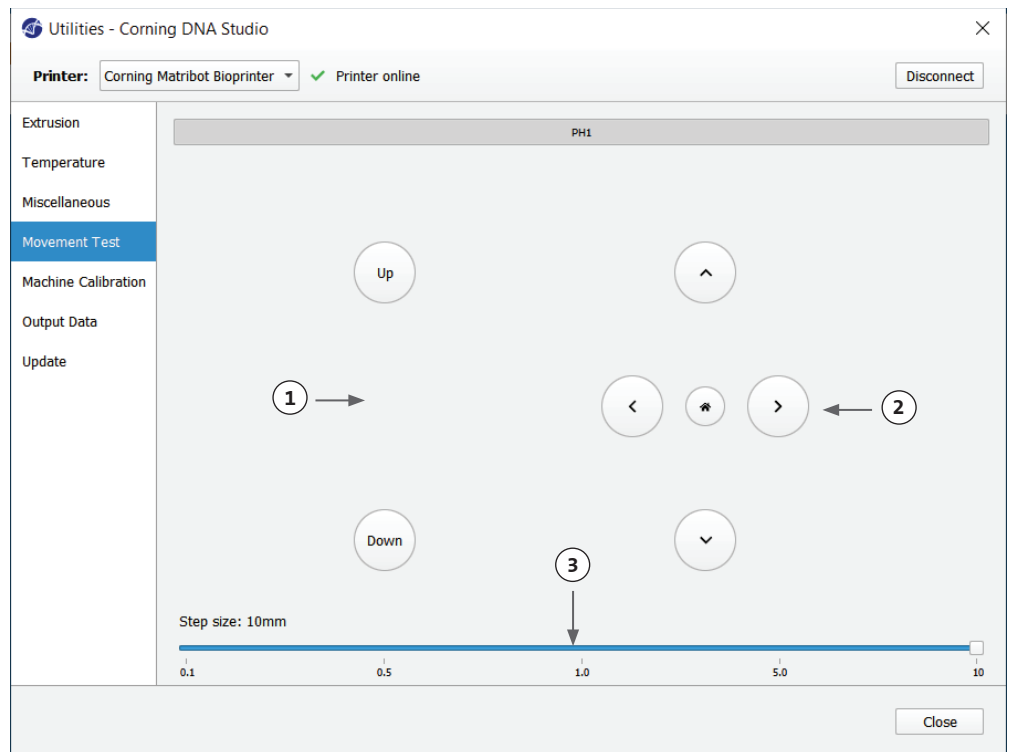

#### 4.5.5 Output data tab

This tab presents output data for customer support. Corning uses this tab to perform sensor testing.

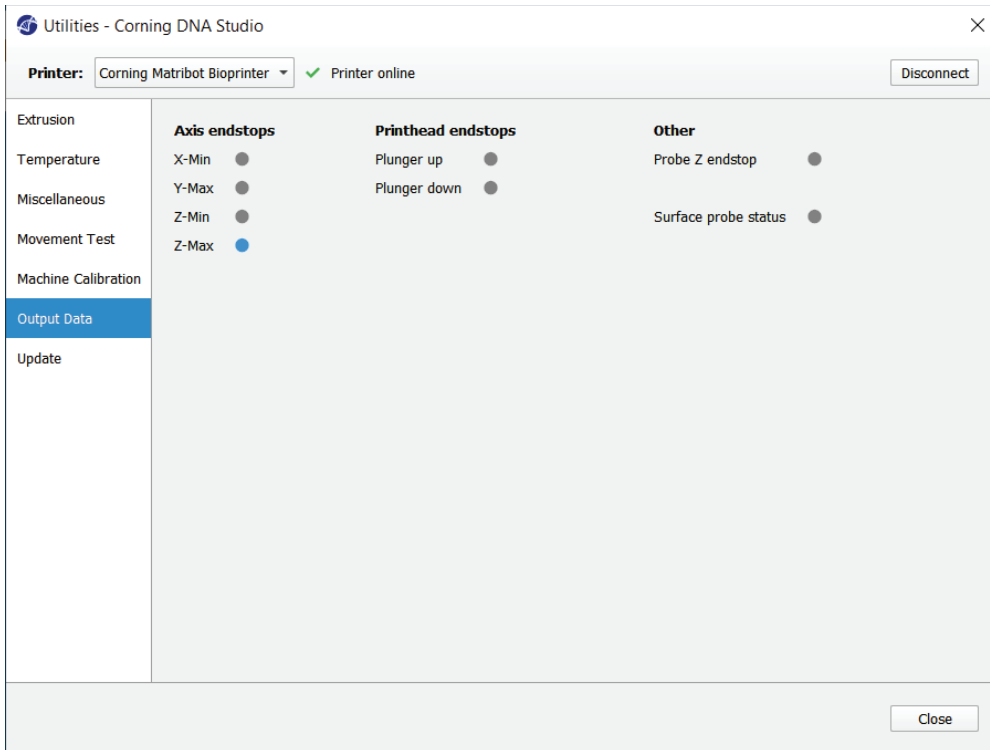

#### 4.5.6 Update tab

Download the firmware update onto your computer. Firmware updates are available at [www.corning.com/matribotguidelines](http://www.corning.com/matribotguidelines). Navigate to the Update tab in the utility's menu. Press Browse and select the file from the list. Press Start Update to perform the update procedure. The update will take a few minutes. Do not disconnect the USB cable or power down the printer until the update is complete.

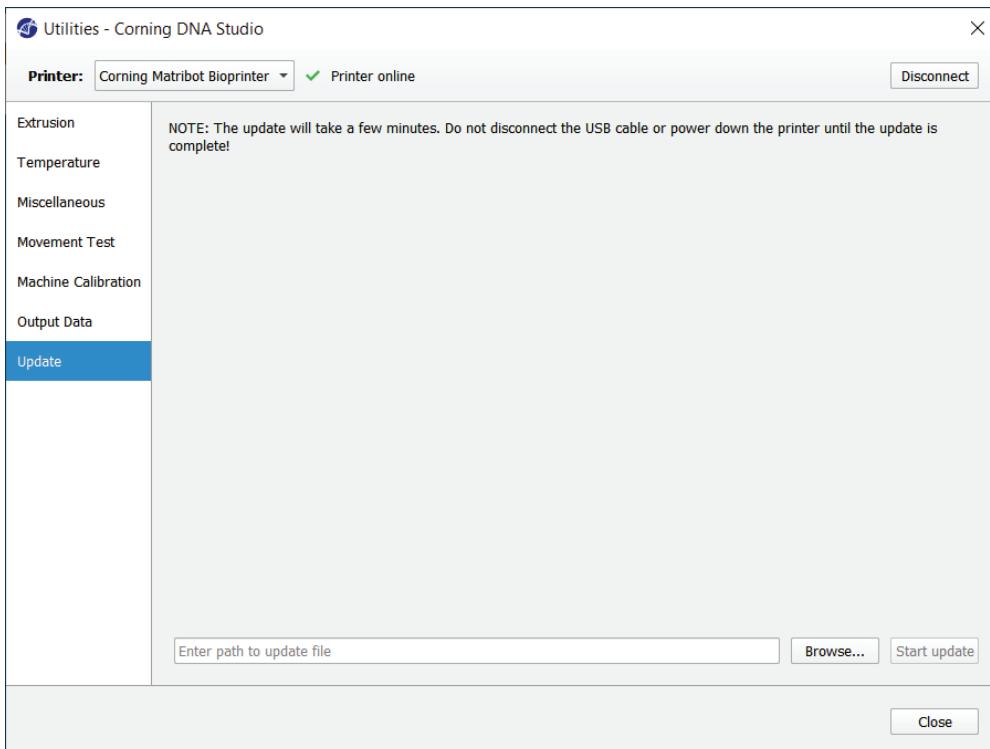

## 5. LCD Interface

The Corning® Matribot® Bioprinter can be used without a connection to the PC. Multiple options such as bioprinting, temperature control, and manual calibration can be accessed on the Corning Matribot Bioprinter's LCD display. The following section describes main functions that can be accessed on the LCD display.

To navigate through the settings on the LCD display, rotate and press the control knob.

### 5.1 Status screen

This screen displays measured and set temperatures of the printhead and the printbed.

1. Measured temperature of the printhead.
2. Set temperature of the printhead. Displays 0°C if temperature control is disabled.
3. Measured temperature of the printbed.
4. Set temperature of the printbed. Displays 0°C if temperature control is disabled.

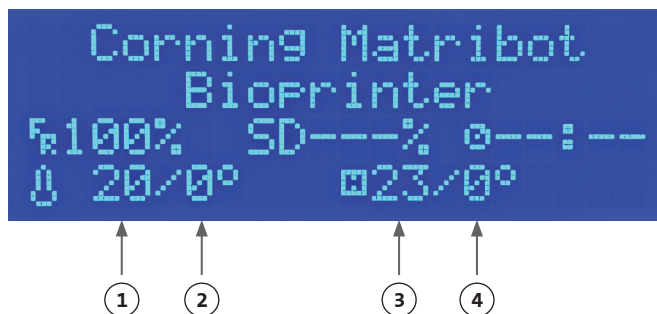

### 5.2 Temperature control

To adjust the temperatures of the printhead and the printbed follow the steps below.

1. Navigate from the status screen to the Prepare Bioprint menu.
2. Scroll down and set the printhead temperature and the printbed temperature.
3. Enable temperature control.



### 5.3 Attach the syringe to the syringe plunger holder

To adjust the position of the syringe plunger holder, navigate to the Prepare Bioprint menu, and select the Raise Plunger function. Using the Extrude Volume function, move the syringe plunger holder to match the position of the syringe plunger.

### 5.4 Printing using g-code file

To bioprint directly from an SD card, follow the steps below.

1. Copy the g-code to the SD card. You can generate your g-code file using Corning DNA Studio to define the printing parameters and exporting the resulting g-code to the SD card.
2. Place the SD card in the SD card slot.
3. Navigate to the Utilities menu.
4. In the Utilities menu select Enable SD print.
5. Set the correct temperature settings according to the instructions in Section 5.2.
6. Place the syringe in the printhead, and attach the syringe plunger holder according to the instructions in Section 5.3.
7. Attach the well plate or the Petri dish of your choice to the printbed.
8. Navigate to the Prepare Bioprint menu, and select the Home Axes function.
9. By using the Move Z function, place the end of the nozzle as close to the printing surface as possible without touching it.
10. If necessary, use Move Axis function in the Utilities menu to move the printhead.
11. Once the nozzle is located close to the printing surface, navigate to the Prepare Bioprint Menu once again, and select Calibrate Z function.
12. Prime the nozzle by extruding a small volume of the bioink using the Extrude Volume function.
13. Navigate to the Bioprint menu by selecting Back, and select the g-code file to start the print.

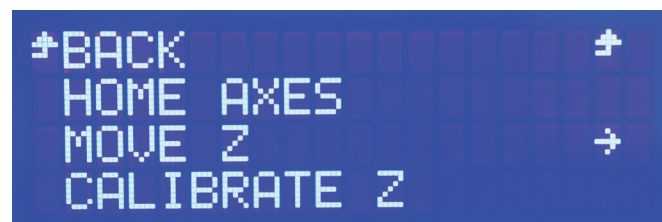
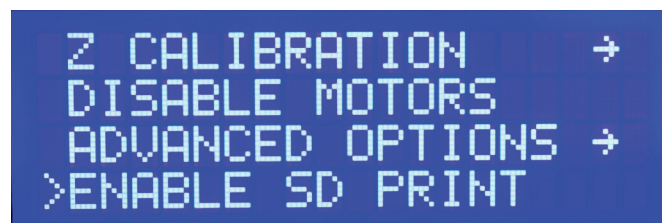
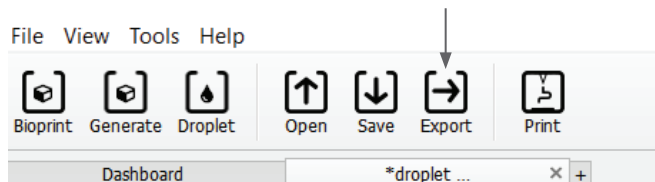

## 6. Maintenance

### 6.1 Maintenance plan



Always turn the power switch to its OFF position, and disconnect the power cord before you clean or do maintenance on the product.

Task	Action	Regularity	Check Dates
Software update	Update Corning® DNA Studio to the latest version. The latest software can always be found on <a href="http://www.corning.com/matribotguidelines">www.corning.com/matribotguidelines</a> .	Every 3 months or when new software is released	
Visual inspection and cleaning	Clean the machine according to the instructions in Section 6.2.	Every time it is used	
Leveling the printbed	Level the printbed using the screws below it according to the instructions in Section 6.3.	Every 3 months or when the device is relocated	
Tensioning the belts	Set proper static tension for Y axis belts according to the instructions in Section 6.4.	Every 24 months or when the belts feel loose	
Clean and lubricate the gantry system	Remove any dirt that is on the rods or the lead screw with a clean, lint-free rag, or by using your finger (with gloves on). Remove the Back Cover Top followed by the Back Cover Bottom to access the Z-gantry rods and lead screw. Use an all-purpose PTFE impregnated grease on the leadscrew only. Use a light machine oil to lubricate the rods only. Re-install the Back Cover Bottom followed by the Back Cover Top.	Yearly or as needed	

### 6.2 Cleaning or sanitizing the Corning Matribot® Bioprinter

Before cleaning, turn off and unplug the Corning Matribot Bioprinter. The Corning Matribot Bioprinter has a chemical-resistant coating. Clean or sanitize it with >70% (v/v) ethanol. Spray the surface, and wipe it with a soft cloth while wearing gloves to avoid direct contact with the unit.



After using ethanol, wait at least 60 seconds before starting the Corning Matribot Bioprinter. Ethanol is flammable, and this ensures that all remaining ethanol vapor is ventilated. Failure to wait can cause equipment damage and personal injury.

Task	Action	Regularity	Check Dates
Clean the gantry system	Remove any dirt that is on the rods or the lead screw with a clean, lint-free rag, or by using your finger (with gloves on).	Every week	
Clean exterior (sides, back, front, top)	Clean the surface with a cloth and ethanol >70% (v/v).	Every week	
Clean LCD screen	Clean carefully with a smooth cloth and without using heavy solvents.	Every week	
Clean printbed	Clean the printbed body with a smooth cloth and ethanol >70% (v/v). Pay special attention to the auto-calibration pad. If needed, the pad can be detached for a thorough cleaning.	Every time it is used	
Clean printhead	Clean the printhead body with a smooth cloth to remove any dust and debris. Check the fan of the printhead for residues or accumulated dirt.	Every time it is used	



### 6.3 Leveling the printbed

It is important to ensure that the printbed is completely leveled relative to the internal axes of your Corning® Matribot® Bioprinter.

1. Verify that the Corning Matribot Bioprinter is disconnected from the power outlet and your computer.
2. Insert an empty syringe with a nozzle into the printhead and manually push the printhead plunger to the lower limit of plunger travel.
3. Screw in all three adjustment screws under the bed tightly. Unscrew the adjustment screw to the back left (A) by approx. 2 turns.
4. Move the printbed and the printhead manually, until the tip of the nozzle touches the surface of the printbed in front of the adjustment screw to the back left (A).
5. Leaving the printbed where it is, manually move the printhead until the nozzle is in front of the adjustment screw to the back right (B). Adjust the butterfly screw until the nozzle touches the surface of the printbed.
6. Again, leaving the printbed where it is, move the printhead until the nozzle is right behind the front adjustment screw (C). Adjust the butterfly screw until the nozzle touches the printbed.

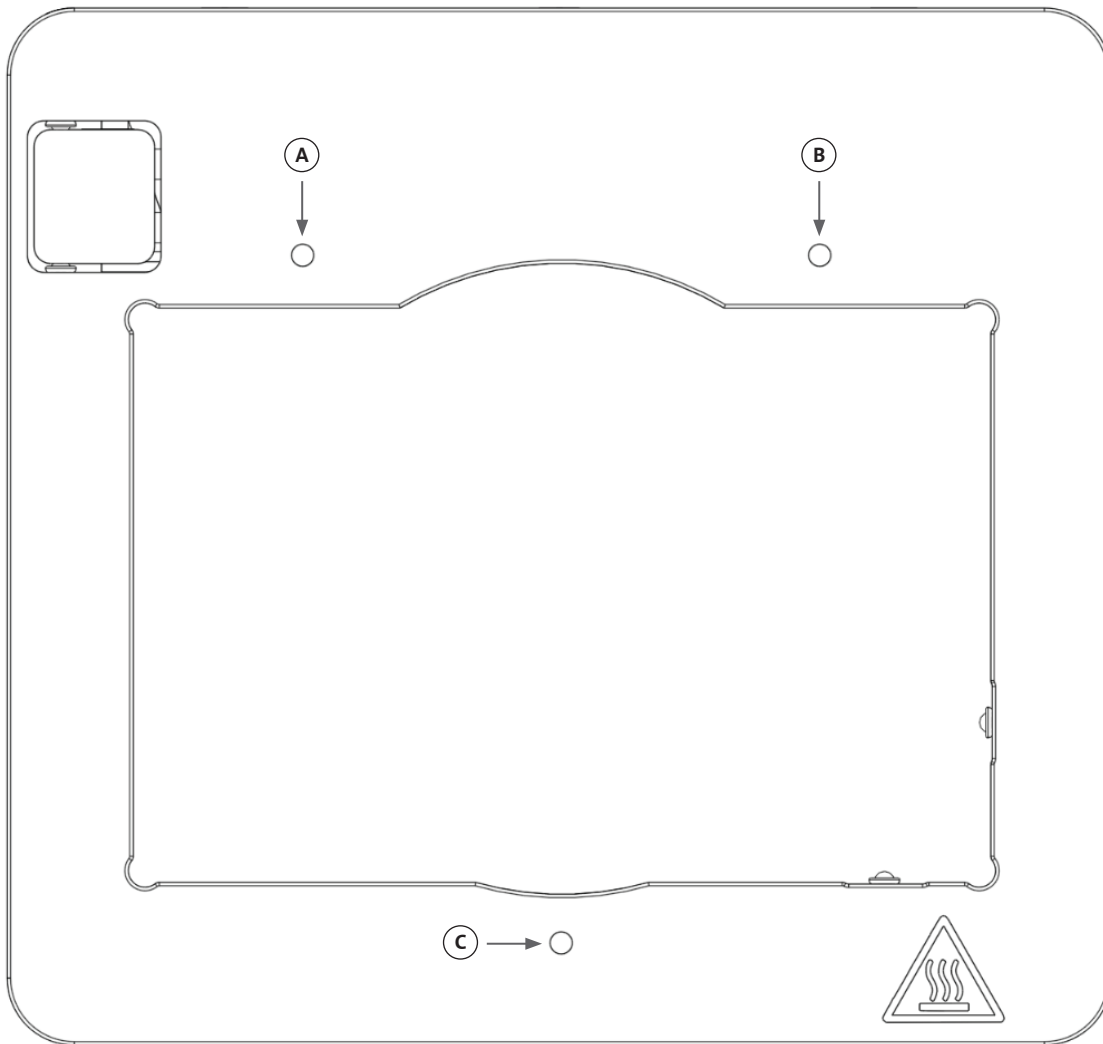

## 6.4 Tensioning the belts

It is important to ensure that the belts of the gantry system are correctly tensioned. Static tensions can be measured by plucking the belt and measuring the natural frequency of generated sound. Follow the steps below to set the correct tension of the belts.

1. Install application “Spectroid” (available for Android and iOS) or other application that measures real-time frequency output.
2. Loosen the set screws in the left pulley (1 and 2) and the set screws in the right pulley (3 and 4).
3. Open the application on your phone.
4. Point the microphone of the phone toward the Y belt on the left side of the device. Pluck the belt, and read the frequency from the analyzer. You should see a frequency spike, and it should drop off slowly as the vibration of the belt decreases over time. For the Corning® Matribot® Bioprinter Y-Gantry belts the ideal frequency is 100Hz +/- 10%. Both of the Y-Gantry belts should be as close as possible in tension with each other.

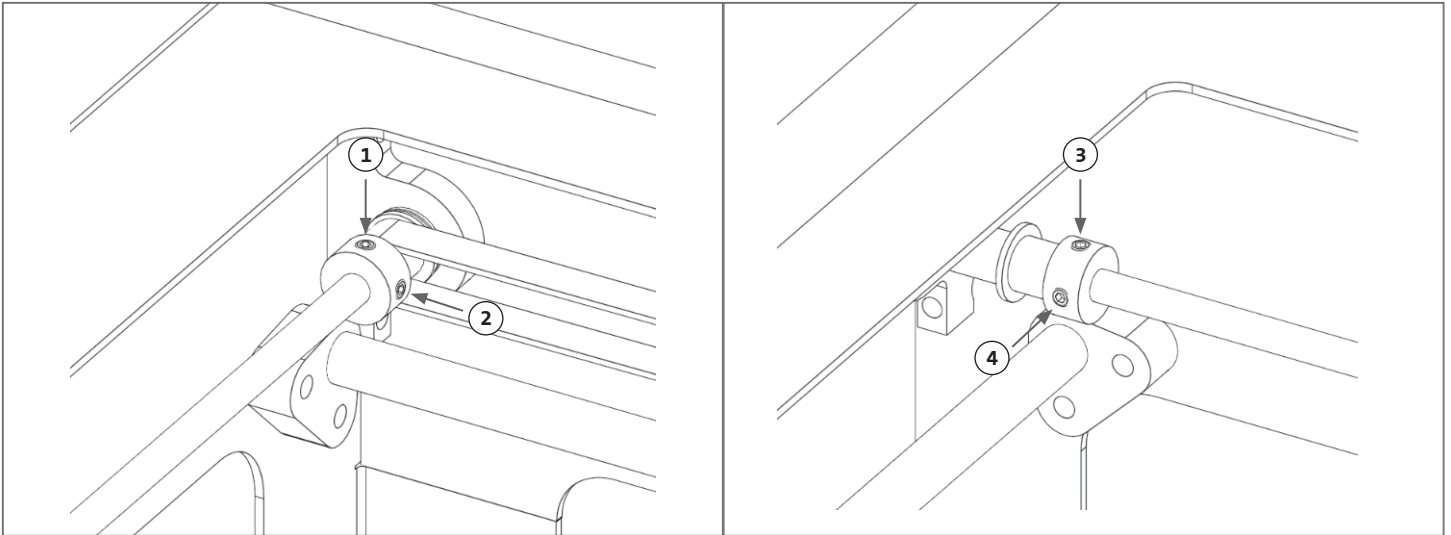

5. If an adjustment needs to be made to the belt tension, begin by loosening the lockdown bolt (5) on the Y-Gantry belt holder. Then adjust the tension by tightening or loosening the tension adjustment bolt (6) located underneath the belt. Measure the frequency following Step 4, and when the tension is appropriate, tighten the lockdown bolt (5).
6. Repeat Steps 4 and 5 for the Y belt on the right side of the device.
7. Tighten the set screws in both pulleys.

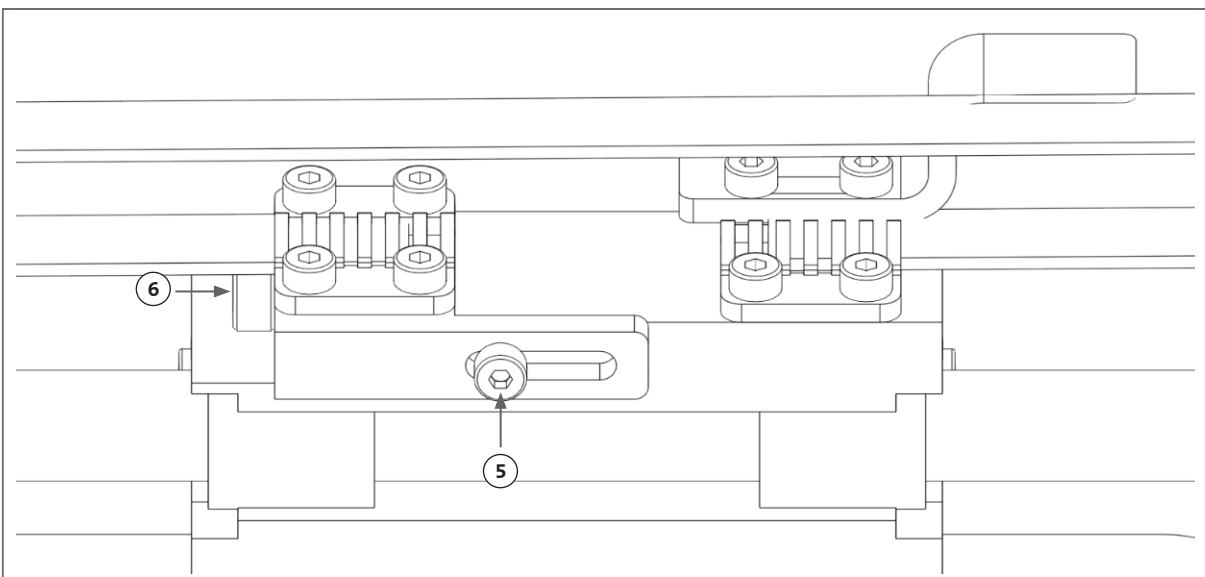

## 6.5 Troubleshooting guide

Keeping your Corning® DNA Studio updated to the latest version is highly recommended and essential for taking advantage of the new features, while avoiding device malfunctions. Use the steps below to update your Corning DNA Studio to the latest software version available.



1. Download the new version of Corning DNA Studio from [www.corning.com/matribotguidelines](http://www.corning.com/matribotguidelines).
2. Uninstall the old version of Corning DNA Studio from your computer.
3. Install new version of Corning DNA Studio on your computer.



### WARNING:

Always turn the power switch to its OFF position and disconnect the power cord before you clean or do maintenance on the product.

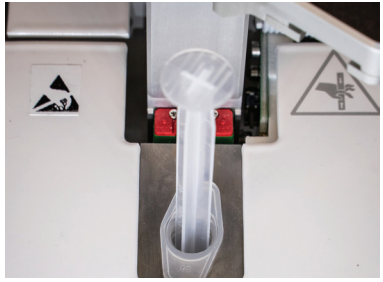
The below points are recommended to troubleshoot your system. If these steps do not resolve your issue, contact Corning Scientific Support.

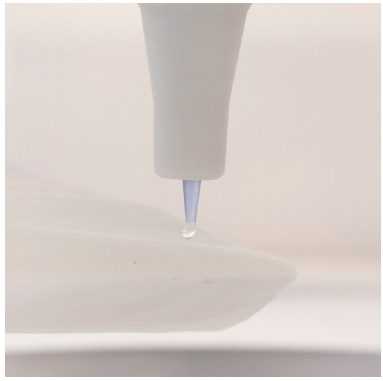
Problem	Cause	Solution	
The system does not power up properly.	The electricity supply has been cut off.	Test another outlet, and ensure nothing else is connected to the outlet.	
		Check the voltage input on the fuse panel to ensure it matches the required voltage on the power supply.	
No material extruded from the nozzle.	Syringe plunger is not connected to the holder arm.	Rotate the syringe plunger holder arm over the plunger and twist the syringe by the tabs counterclockwise to ensure it is locked in place.	
	Material is dried or clogged.	Clogging at the nozzle tip may occur due to gelation or drying of the material. Pre-set the printhead temperature to 2°C before beginning any procedure with temperature-sensitive materials, and make sure to fully purge the nozzle of 30 to 60 µL of material before starting a new print to extrude any gelated material. If the material has dried and the clog cannot be removed, replace with a new nozzle.	
	Nozzle is not primed.	Always ensure the nozzle is fully primed with well flowing material before starting each print. This is done preferably after machine calibration.	
Extrusion is not consistent.	Air bubbles are trapped in the material.	Use a centrifuge to remove bubbles from the material.	

Problem	Cause	Solution
Print not starting.	Temperatures are not reaching desired levels.	Preferably set the temperatures as soon as possible to reduce the waiting time with the material ready. If changing the set temperature to the actual temperature, the printing will start right away.
	Printer is not calibrated.	Perform a machine calibration: manual or automatic.
Corning® DNA Studio issues.	Corning DNA Studio cannot find the printer.	Make sure the printer is properly connected to the computer via the supplied USB cable and that the printer is turned on.
	Autocalibration, bioprinting, or biodispensing doesn't start.	Disable printing from SD card mode in utilities tab in the Corning Matribot® Bioprinter's LCD interface.
	Other issues with Corning DNA Studio.	Run Corning DNA Studio as Administrator.
Nozzle insulator detached.	Insulator is not attached properly.	Attach the thermal insulator to the cooling block, by inserting it from below and rotating counterclockwise.
	Syringe is not connected properly.	Rotate the syringe plunger holder arm over the plunger, and twist the syringe by the tabs <b>counterclockwise</b> to ensure it is locked in place.
Automatic calibration is not accurate.	Nozzle is too close to the surface.	Increase the z-offset.
	Printbed is tilting.	Perform Automatic bed-leveling, or adjust the screws on the bed to level it.

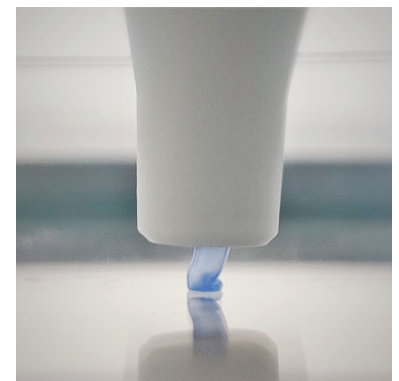
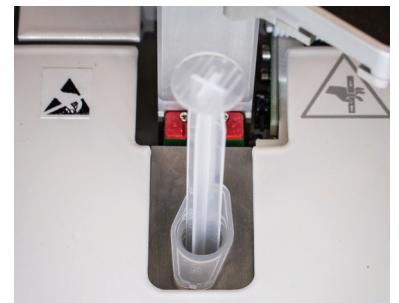
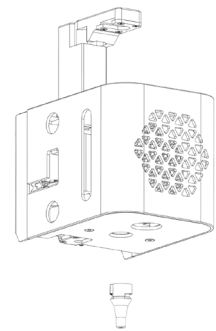
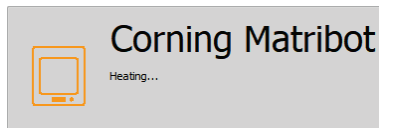

Problem	Cause	Solution
The droplets are not centered in the well plate.	Wrong well plate vendor selected.	In the Surface tab, select the corresponding well plate vendor for the most accurate positioning in all wells.
	Automatic calibration is off-center.	Change to manual calibration to adjust the X, Y, and Z set point exactly as desired.
The error “Connection to the printer timed out” in Corning® DNA Studio.	Connection to the printer has been broken.	Make sure the USB cable is connected to the device and the computer.
	Corning Matribot® Bioprinter SD card mode is enabled.	Disable printing from SD card mode in the utilities tab in the Corning Matribot Bioprinter’s LCD interface.
The Bioprint is not showing up in the menu of the LCD interface.	SD card is not properly inserted.	Verify that the SD card is properly inserted in the SD card reader.
	Corning Matribot Bioprinter SD card mode is not enabled.	Enable printing from SD card mode in the utilities tab in the Corning Matribot Bioprinter’s LCD interface.
Control knob is not responding when pressed.	The knob is pushed all the way in.	Pull the knob gently towards you.

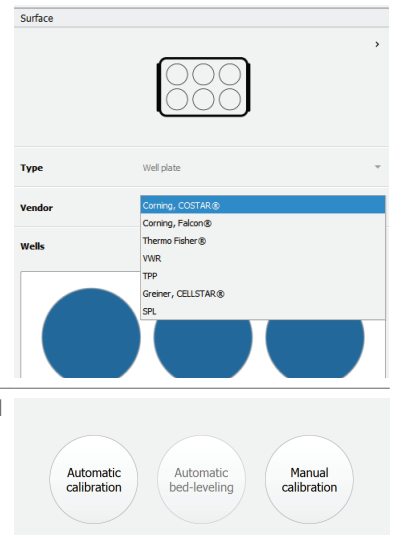

## 7. Limited Warranty

We warranty that you will receive our product tested, working, and fully assembled. This warranty will expire 12 months after the shipment of the product to you. This warranty excludes any warranty relating to software, which shall be subject to the end user license agreement between you and the original equipment manufacturer. Corning is not in any way responsible for any consequential losses or downtime, including those caused by a problem in the performance of our products or a failure to conform to any warranty. Corning is not responsible for additional customs fees and tariffs. Corning is not responsible for delivery delays or the inability to deliver from the carrier. Corning is not responsible for damages resulting from improper handling during delivery. The warranty also does not cover any damages brought about because of an accident. All warranties are voided if the product has been moved from the original country of purchase. The warranty does not cover any alterations or repairs made by a third party. Corning provides no warranty as to the safety or performance of modified Corning® Matribot® Bioprinter devices and we are not responsible for incorrect voltage being used, environmental conditions (moisture, fire, water, flood, lightning, ext.), or any other form of neglect on the customer's part, and any such events or modifications will void this warranty. Corning is not responsible for damages caused by the use of old information or instructions, with the latest version of information and instructions available on our website at [www.corning.com/matribotguidelines](http://www.corning.com/matribotguidelines). The warranty covers critical components only. For example, Corning will not replace a bioprinter because of a perceived blemish in the paintjob. The critical components/replacement parts do not carry a warranty themselves and are only covered in the initial 12 months warranty starting on the shipment date. Components not included in the warranty include timing belts, linear ball bearings, rods, and the build platform. Moving parts must be properly maintained, serviced and/or oiled, and the failure to do so will result in progressed wearing and tearing, and will void the warranty. The heated build platform will be subjected to unavoidable scratching and wear upon use. There is no warranty issued when exotic printing material is used with the Corning Matribot Bioprinter and doing so is not recommended by us at Corning. Foreign materials can damage the system. The warranty does not cover operating the bioprinter at not recommended speeds and settings. In the case that a repair is determined to be outside of the warranty and the buyer decides to send back the Corning Matribot Bioprinter for repair, all shipment and repair costs will be at your expense. Corning will determine in its sole discretion as whether an issue is covered under the warranty.

### Concerning Unauthorized Returns

Returns not pre-authorized will not be eligible for repair, replacement, or refund. Do not send a product back to Corning unless you have contacted us first and we have authorized you to send it.

### Limitations and Confirmation

By using the product, you agree to the terms stated herein, including the warranties. In the event that any products do not conform to the warranty during the warranty period, Corning will, at its option, provide a replacement, repair the product, or grant you an appropriate credit. One of these alternatives shall be your 's sole and exclusive remedy in the event of delivery of non-conforming product. The warranty and remedies provided herein shall apply to the exclusion of any other warranties (express or implied, including the warranties of merchantability and fitness for a particular purpose) or remedies that might otherwise be available under applicable law, including those relating to intellectual property. Corning makes no warranty as to the use or performance of the product. No warranty or representation or guaranty is made by Corning as a result of the delivery of any sample, prototype, product information sheet, sale or marketing material, custom, trade practice, or statement by a representative of Corning. You assume responsibility for selecting the solution to achieve your intended results, and for the installation of, use of, and results obtained from the product and its software. Without limiting the foregoing provisions, Corning makes no warranty that the product or software will be error-free or free from interruptions or other failures or that the product or software will meet your requirements. In no event will Corning be liable to you under any circumstances for any consequential, incidental, indirect, special, or punitive damages such as loss of capital, loss of use, substitute performance, loss of production, loss of profits, loss of business opportunity or any other claims for damages arising hereunder, even if advised of the possibility of such damages. Corning's maximum liability for all damages arising hereunder, regardless of the cause of action or the basis or type of liability, is limited to an amount not to exceed the purchase price for the affected product.

## 8. Equipment Disposal



According to Directive 2012/19/EU of the European Parliament and of the Council of 4 July 2012 on waste electrical and electronic equipment (WEEE), the Corning Matribot Bioprinter is marked with the crossed-out wheeled bin and must not be disposed of with domestic waste.

Consequently, the buyer shall follow the instructions for reuse and recycling of waste electronic and electrical equipment (WEEE) provided with the products and available at the following link: [www.corning.com/weee](http://www.corning.com/weee).

**Warranty/Disclaimer:** Unless otherwise specified, all products are for research use or general laboratory use only.\* Not intended for use in diagnostic or therapeutic procedures. Not for use in humans. These products are not intended to mitigate the presence of microorganisms on surfaces or in the environment, where such organisms can be deleterious to humans or the environment. Corning Life Sciences makes no claims regarding the performance of these products for clinical or diagnostic applications. \*For a listing of US medical devices, regulatory classifications or specific information on claims, visit [www.corning.com/resources](http://www.corning.com/resources).

**CORNING**

**Corning Incorporated**  
*Life Sciences*

[www.corning.com/lifesciences](http://www.corning.com/lifesciences)

**NORTH AMERICA**

t 800.492.1110  
t 978.442.2200

**ASIA/PACIFIC**

**Australia/New Zealand**

t 61 427286832

**Chinese Mainland**

t 86 21 3338 4338

**India**

t 91 124 4604000

**Japan**

t 81 3-3586 1996

**Korea**

t 82 2-796-9500

**Singapore**

t 65 6572-9740

**Taiwan**

t 886 2-2716-0338

**EUROPE**

[CEurope@corning.com](mailto:CEurope@corning.com)

**France**

t 0800 916 882

**Germany**

t 0800 101 1153

**The Netherlands**

t 020 655 79 28

**United Kingdom**

t 0800 376 8660

**All Other European Countries**

t +31 (0) 206 59 60 51

**LATIN AMERICA**

[grupoLA@corning.com](mailto:grupoLA@corning.com)

**Brazil**

t 55 (11) 3089-7400

**Mexico**

t (52-81) 8158-8400